

# Vincenne Art University

Yasuyuki Fukuda Simpei Kojima Keigo Nakamura

■ Protocol

Building

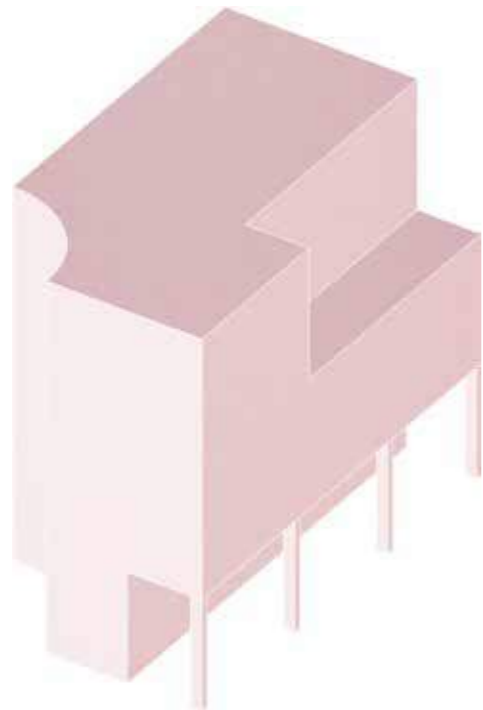

Garden

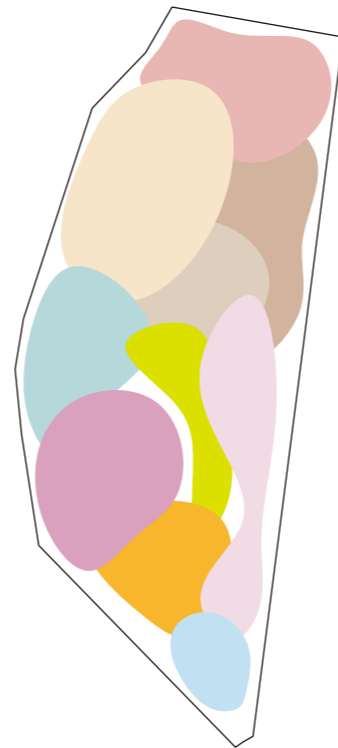

Way



School

Character area

Pass/Waiting



■ Protocol

Building

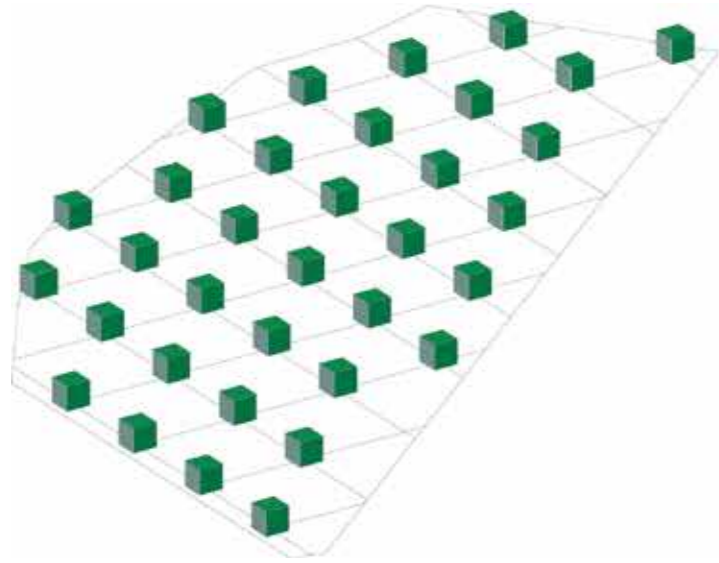

Garden



Way

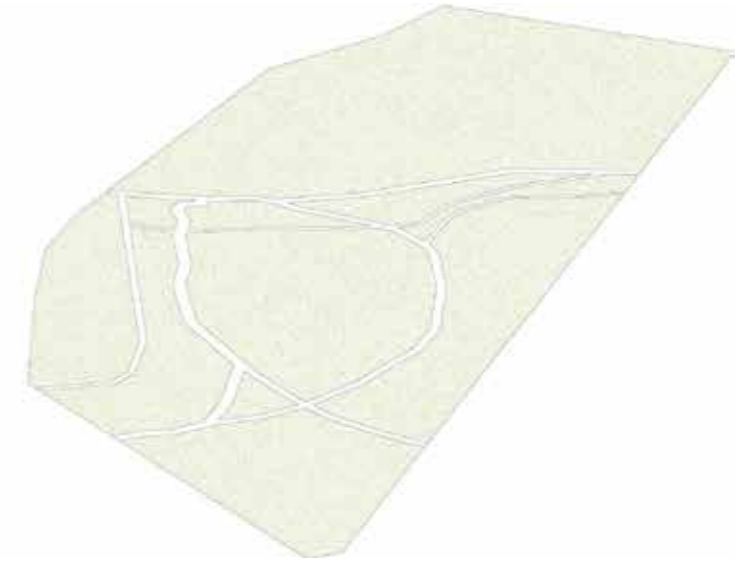

Function/Form

Character

Connector/Segment

■ Constitution

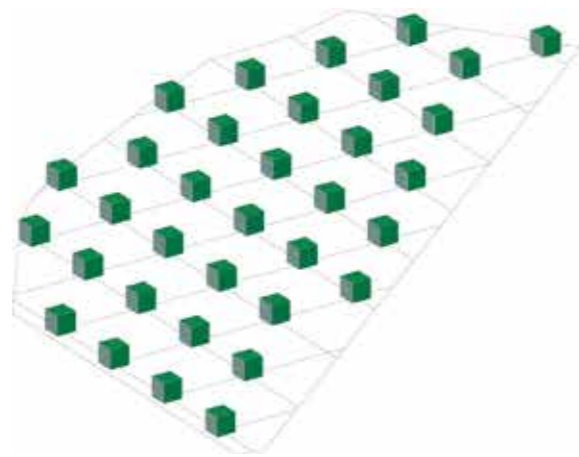

building

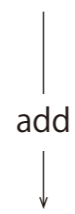

Function/Form



garden

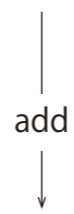

Character

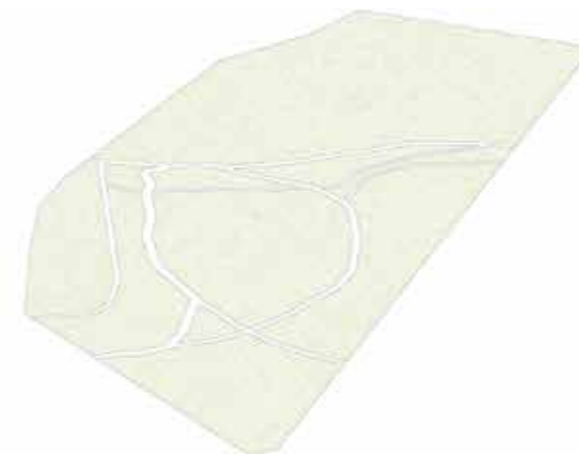

way

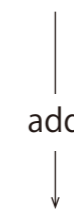

Connector/Segment

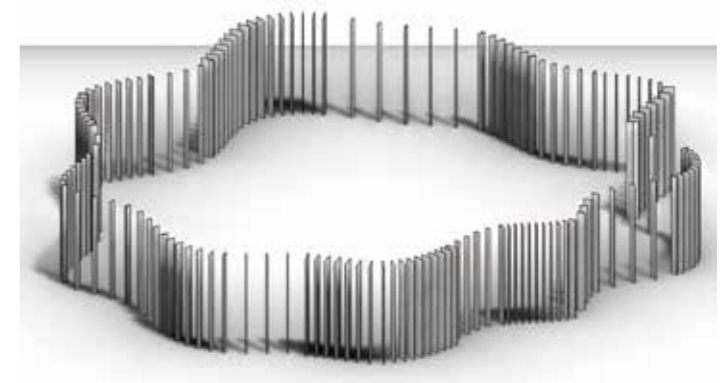
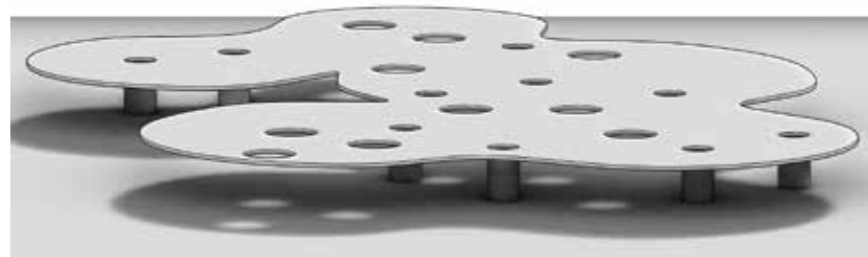
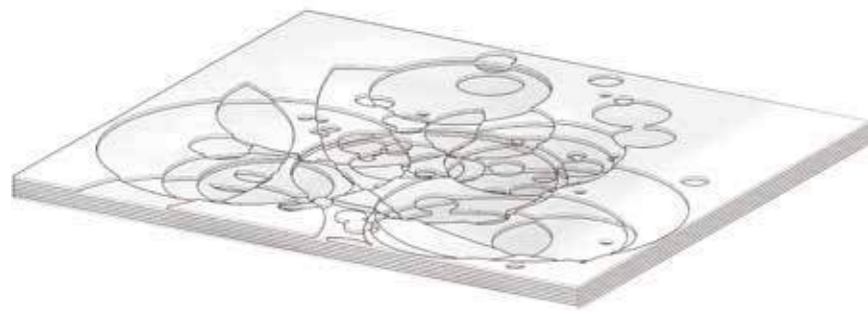
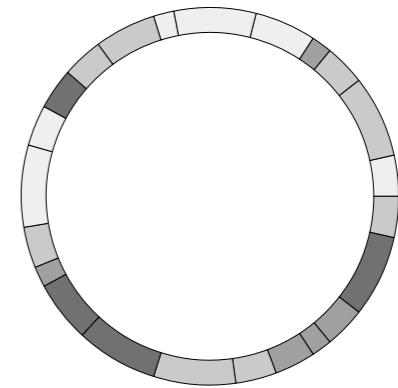
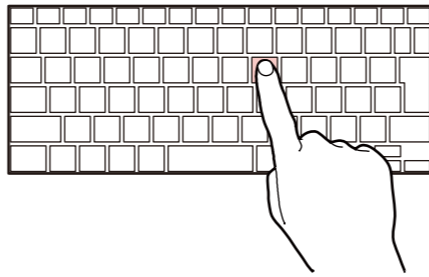

slab

roof

column

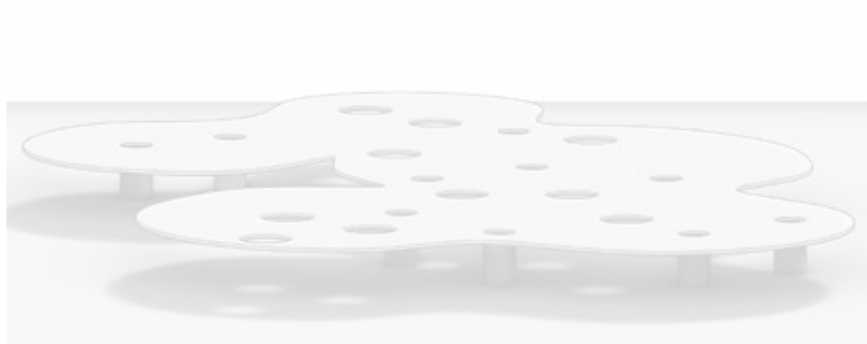
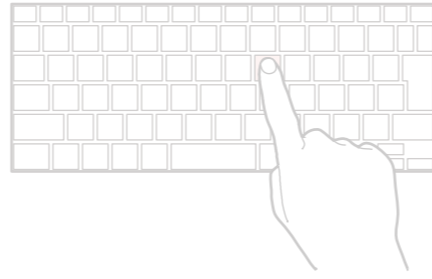
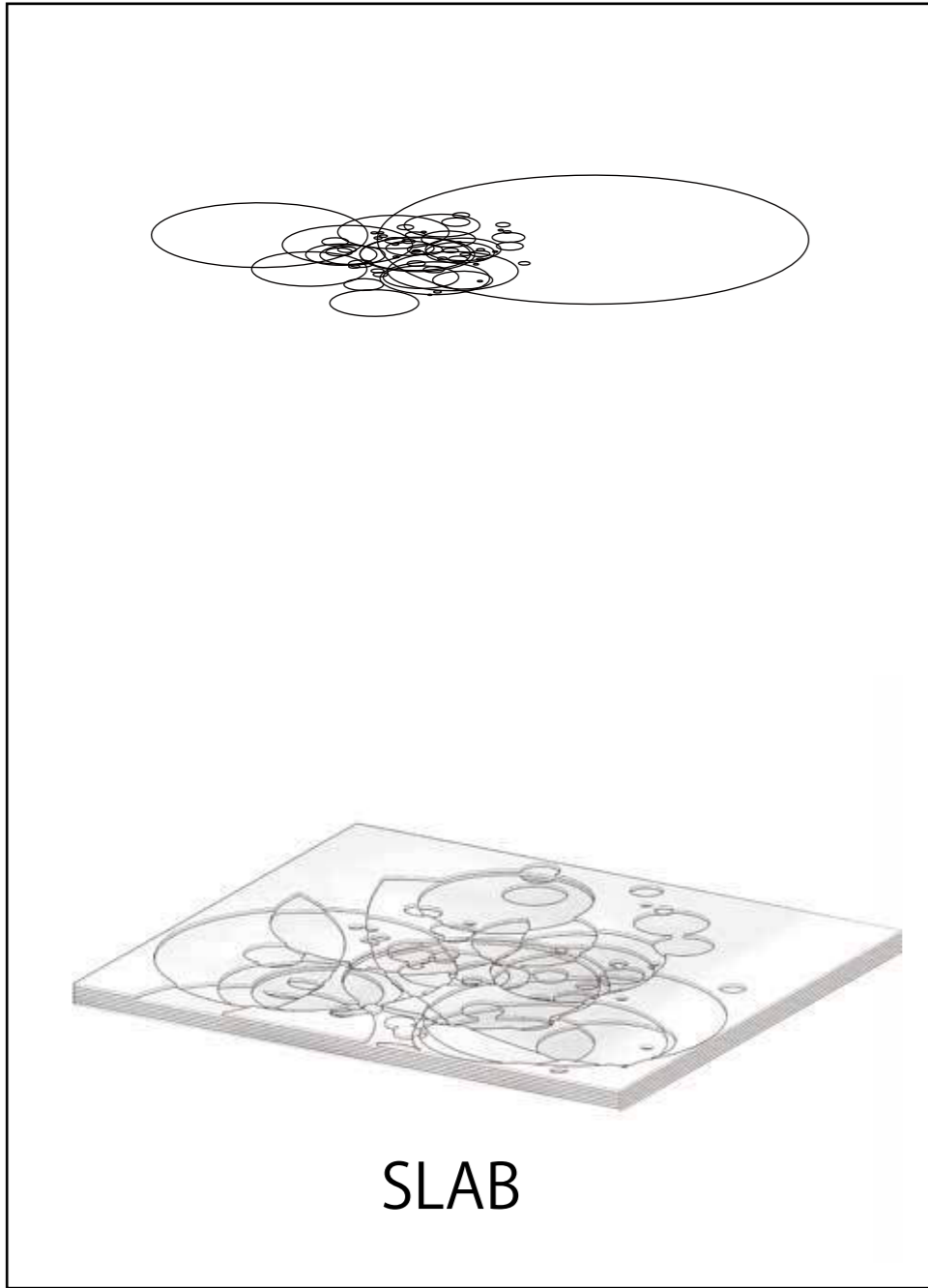

roof

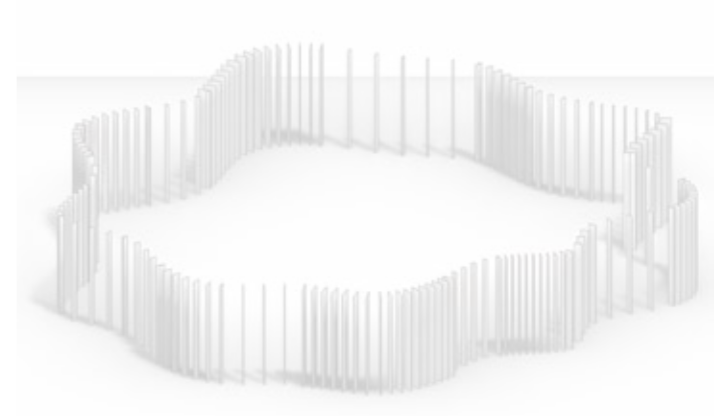
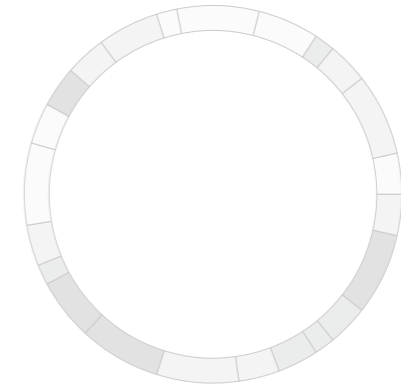

column



## STEP 2 Extract Winding Roads

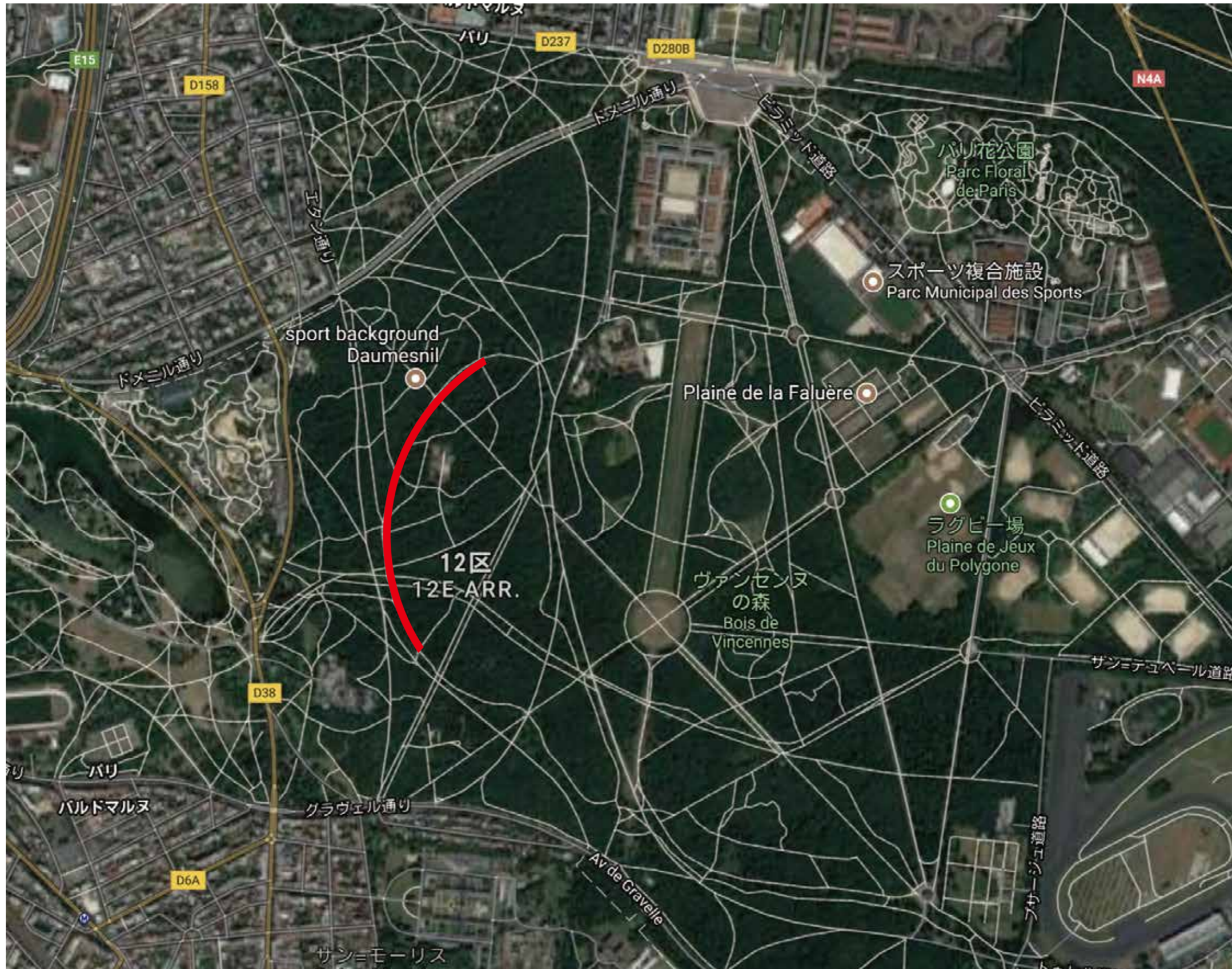



## STEP 2 Create circles

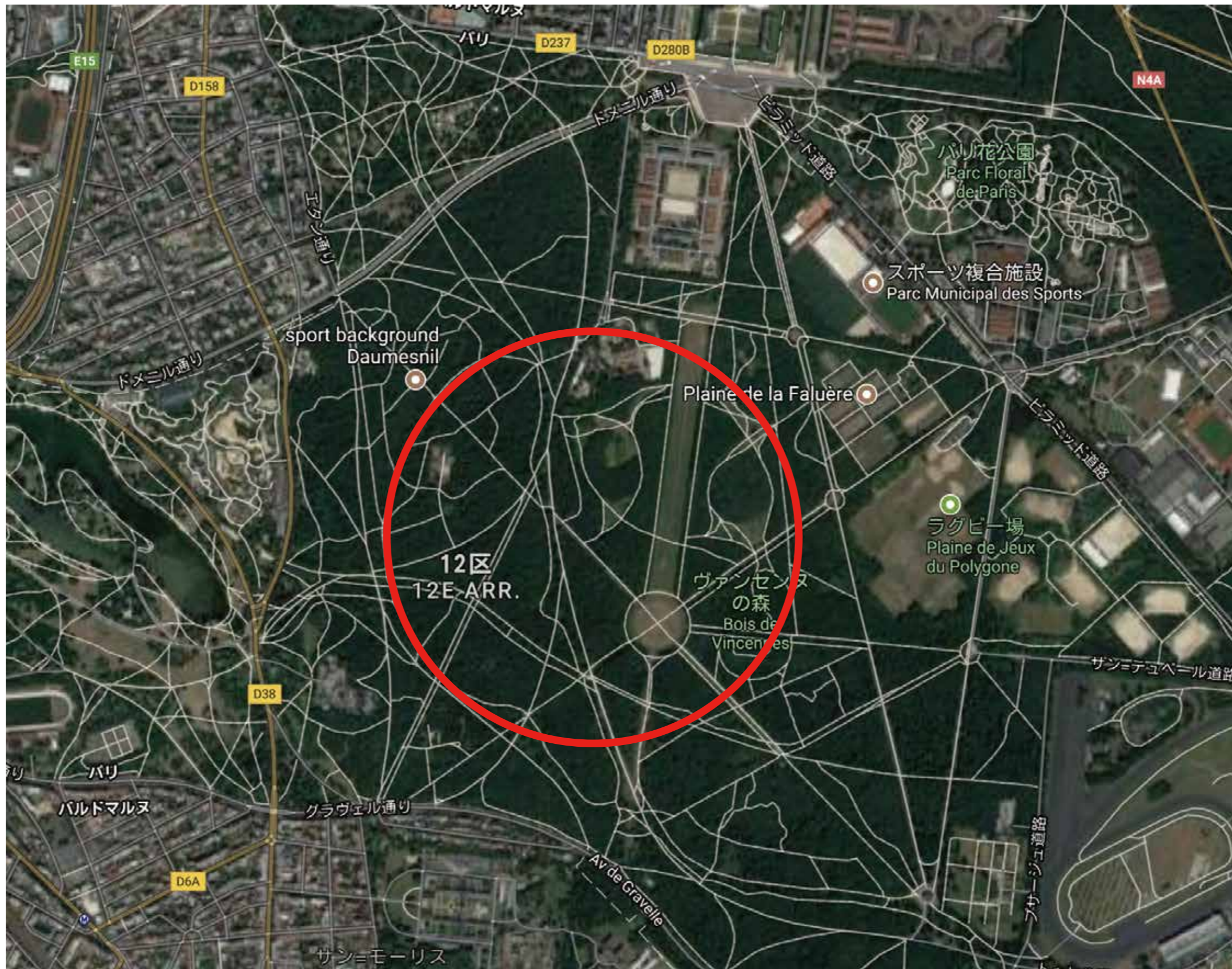



## STEP 2 Create circles



### STEP 3 Analyze circles

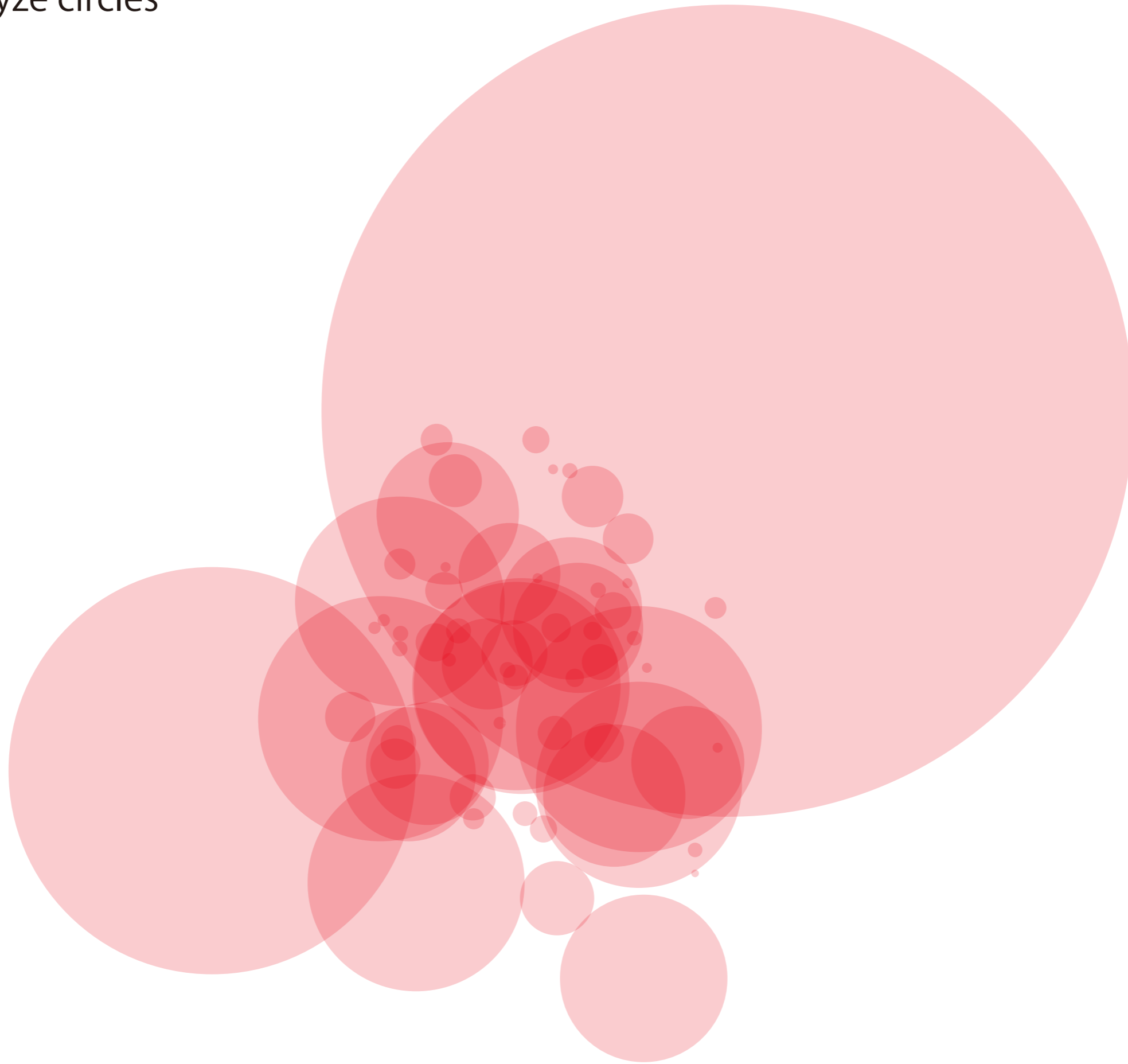



# Overlap

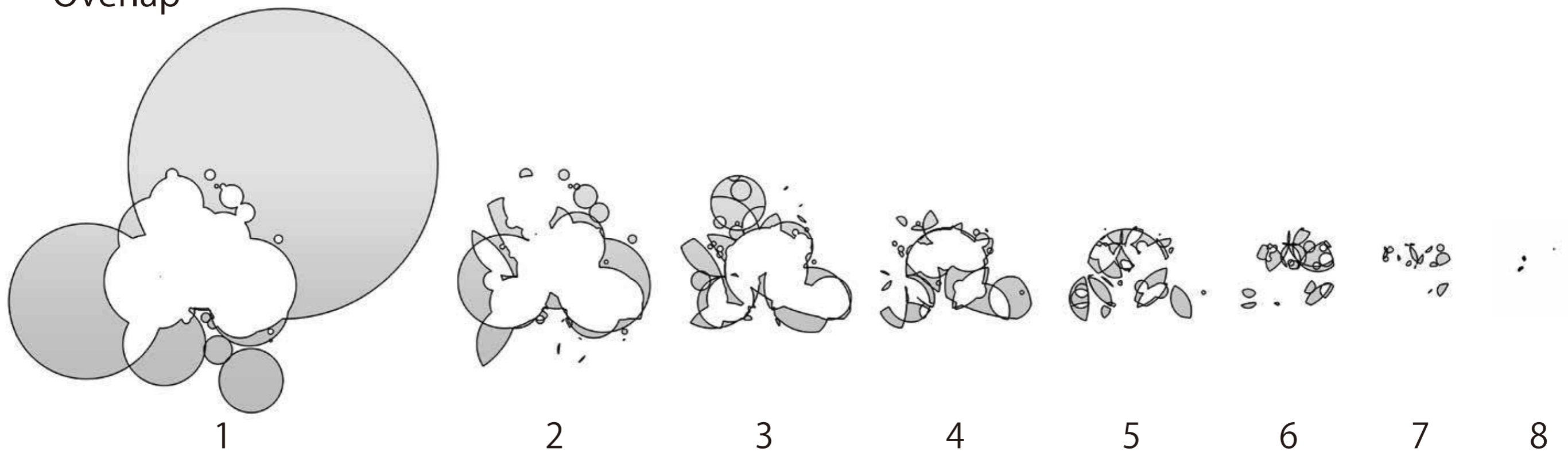

# Proximity center point

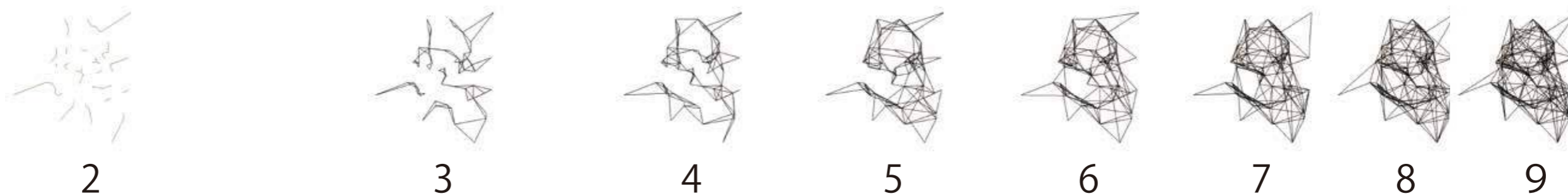

# Proximity intersection

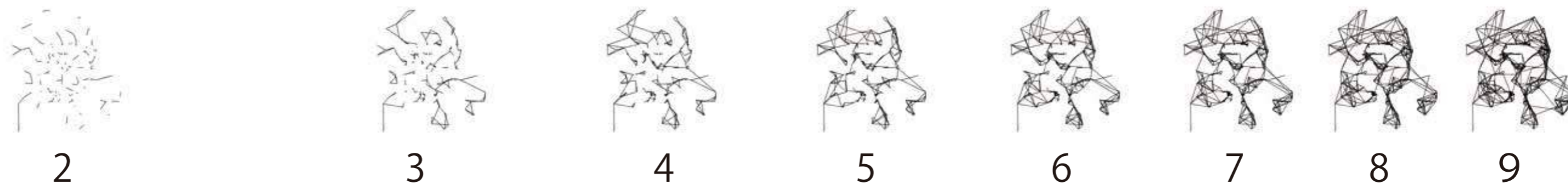

Proximity center point

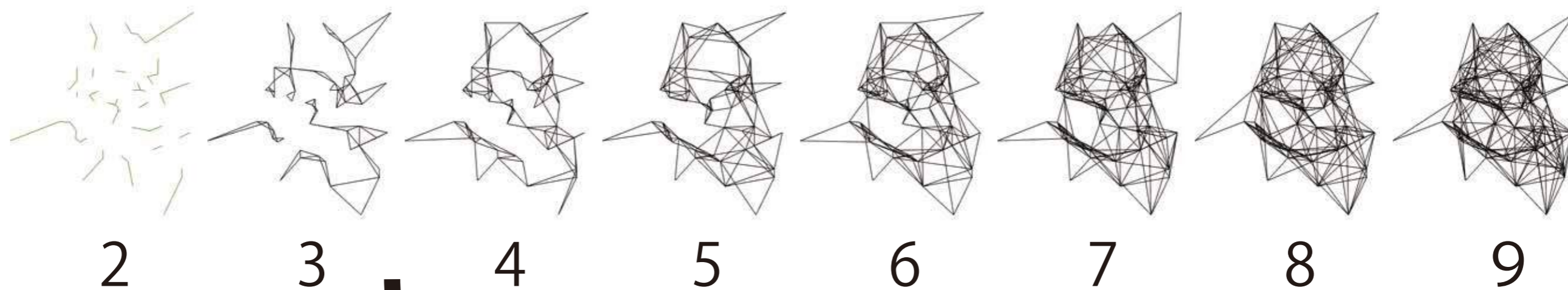

Placement plan

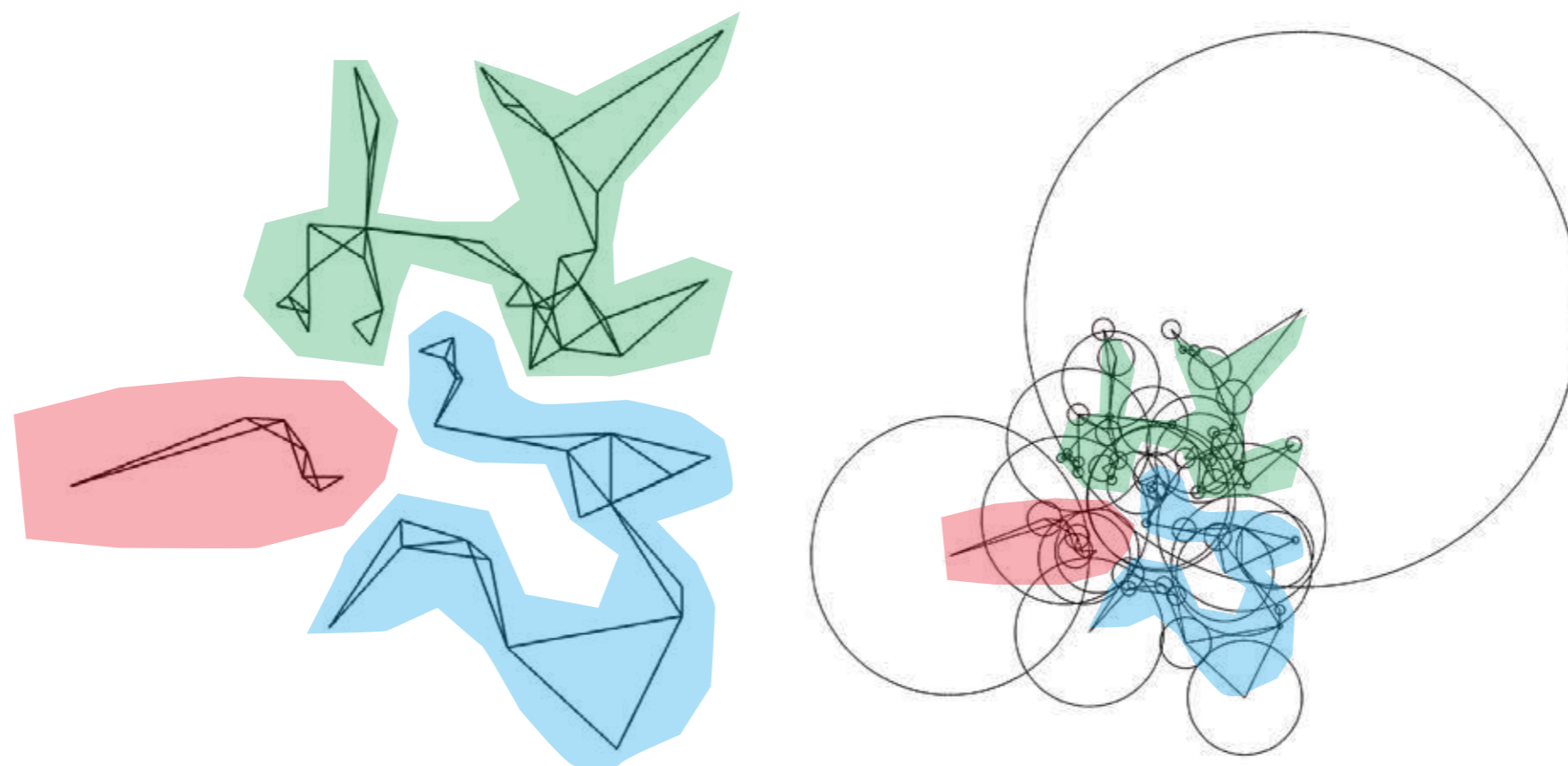

# Proximity intersection

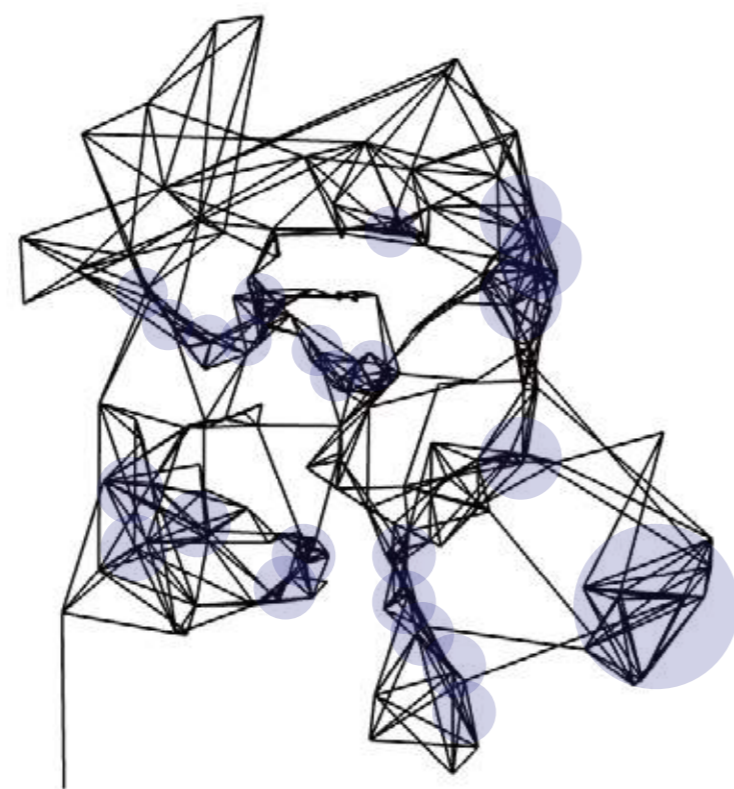
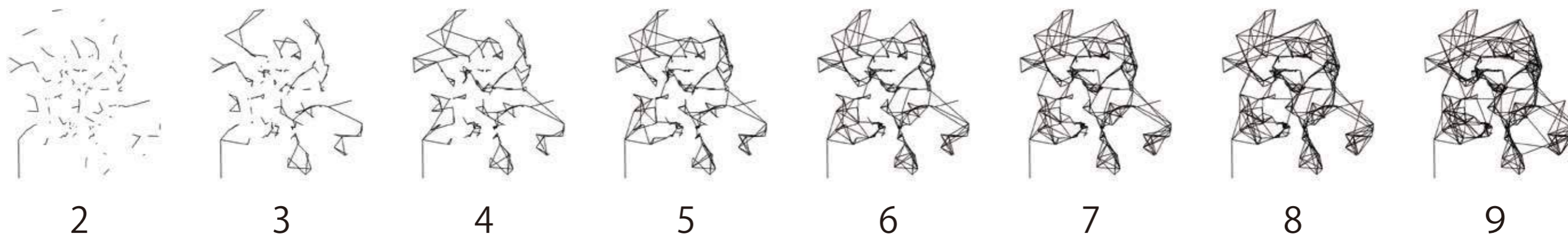

Dence

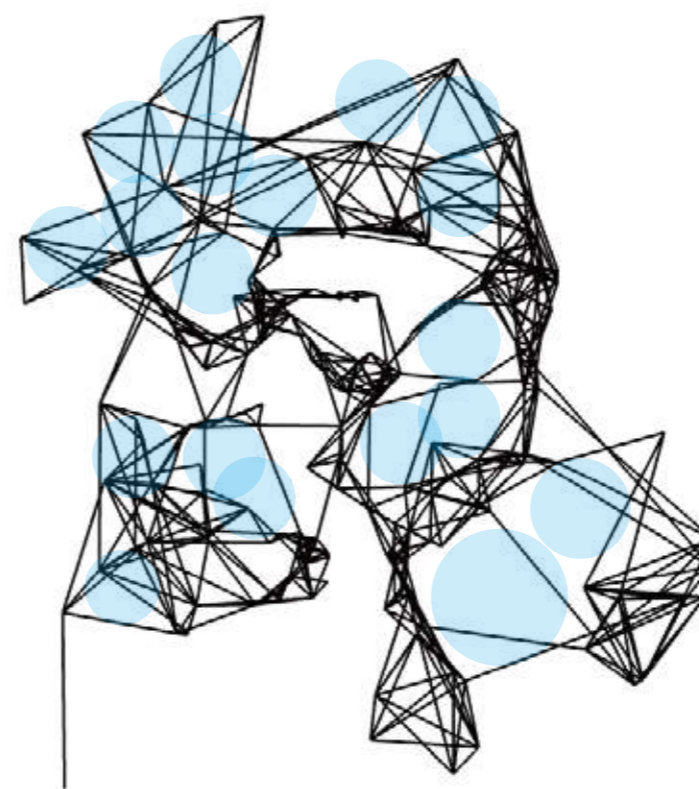

Sparse

■ Slab

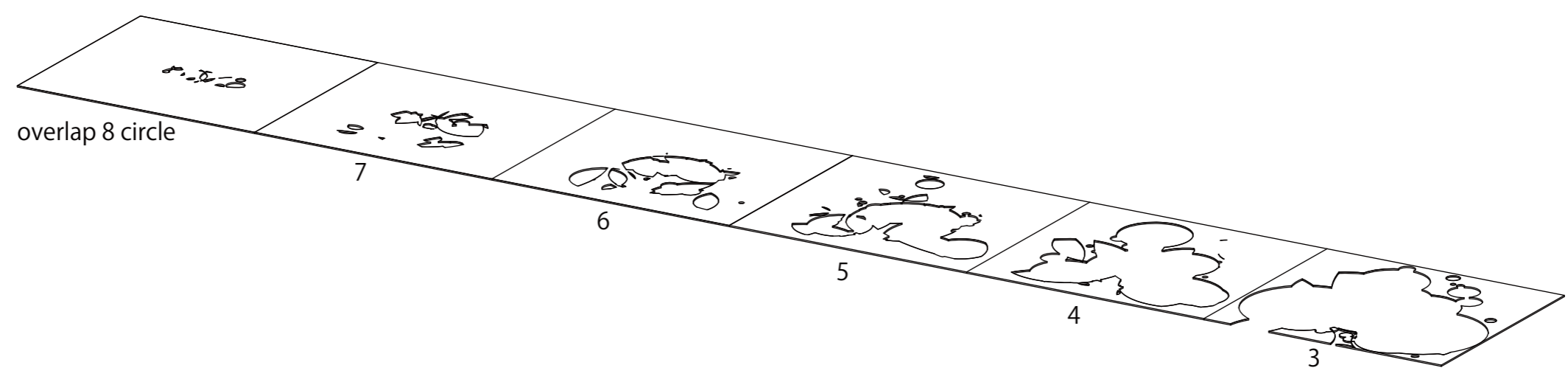
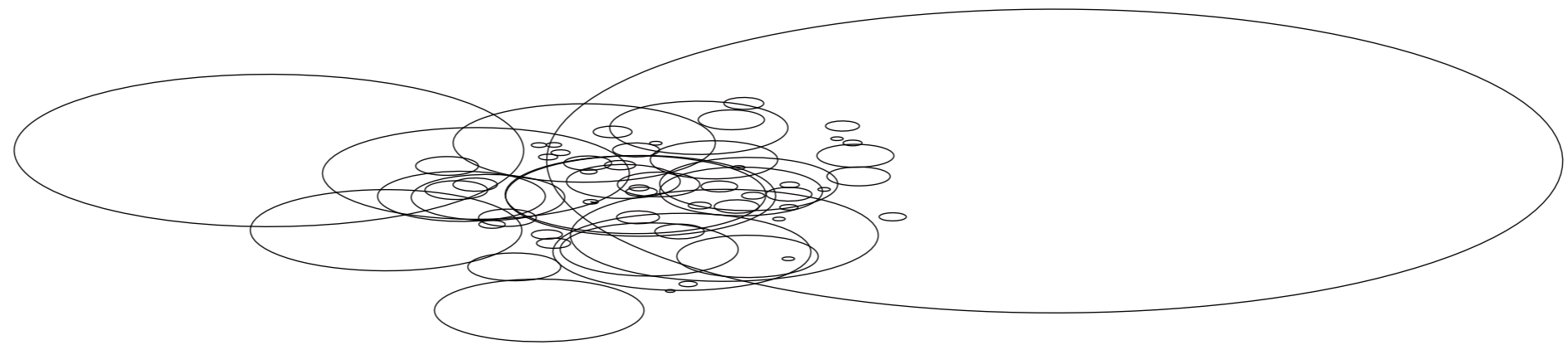



■ Slab

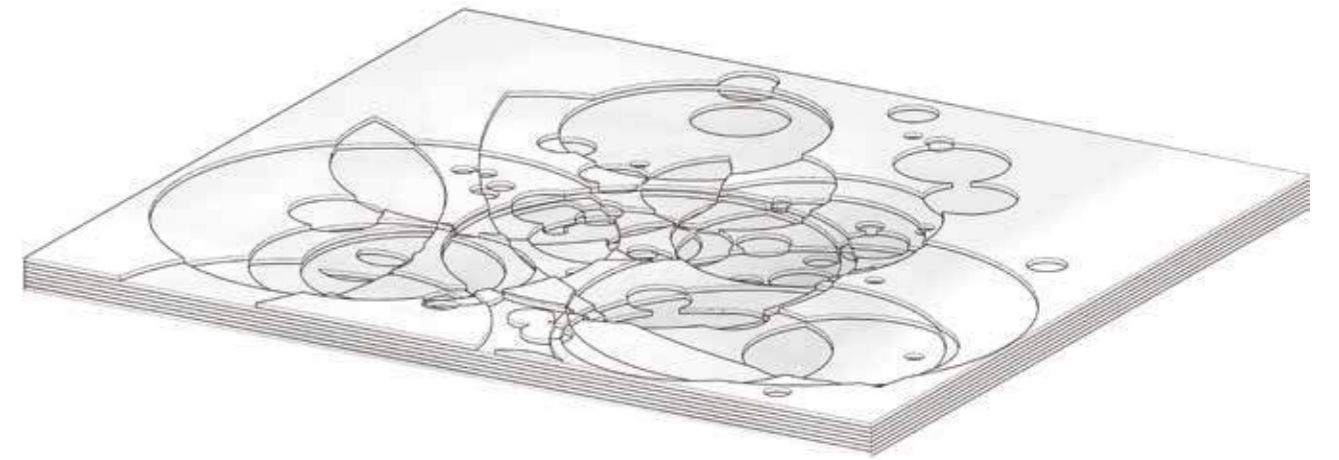
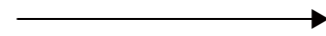
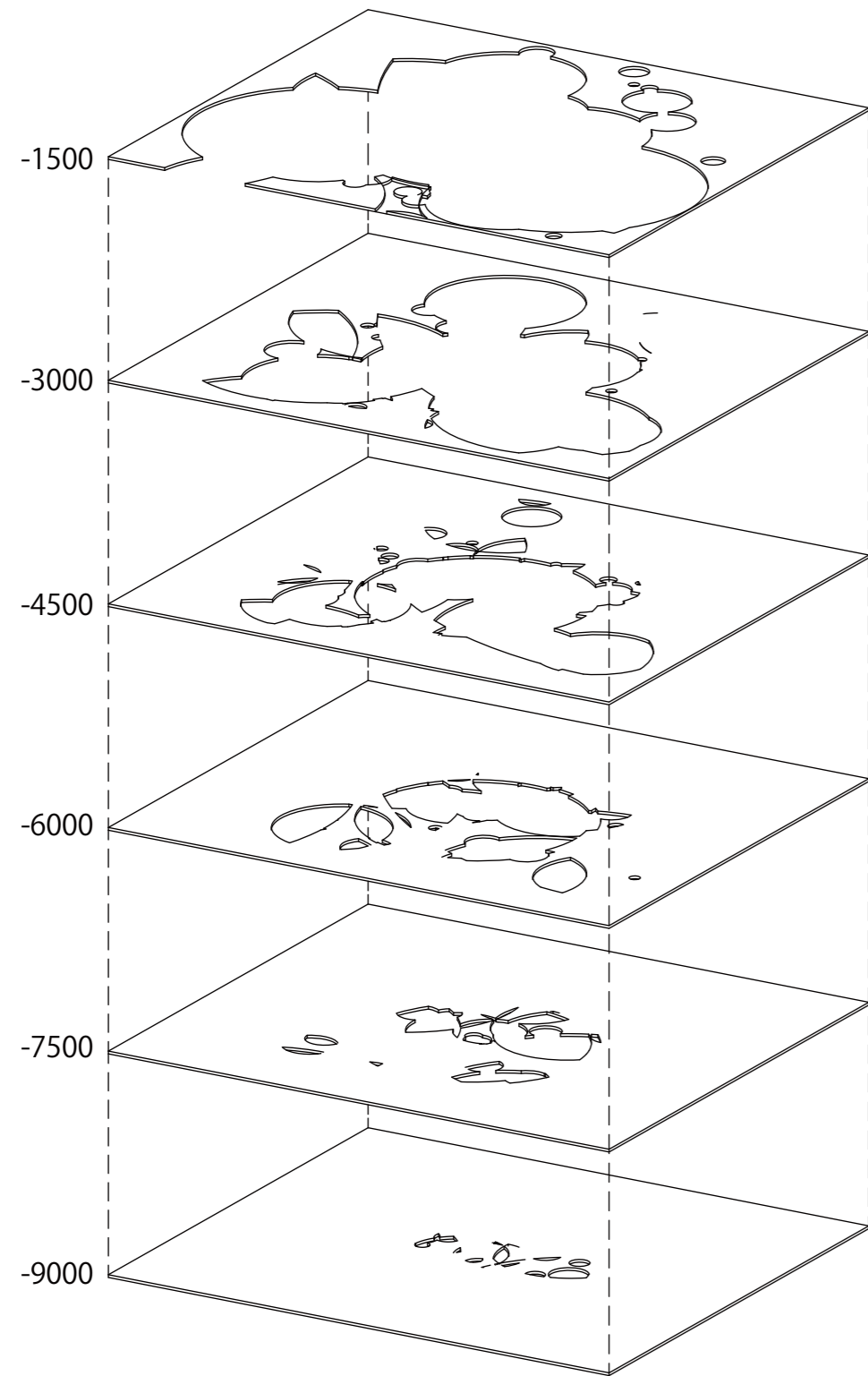

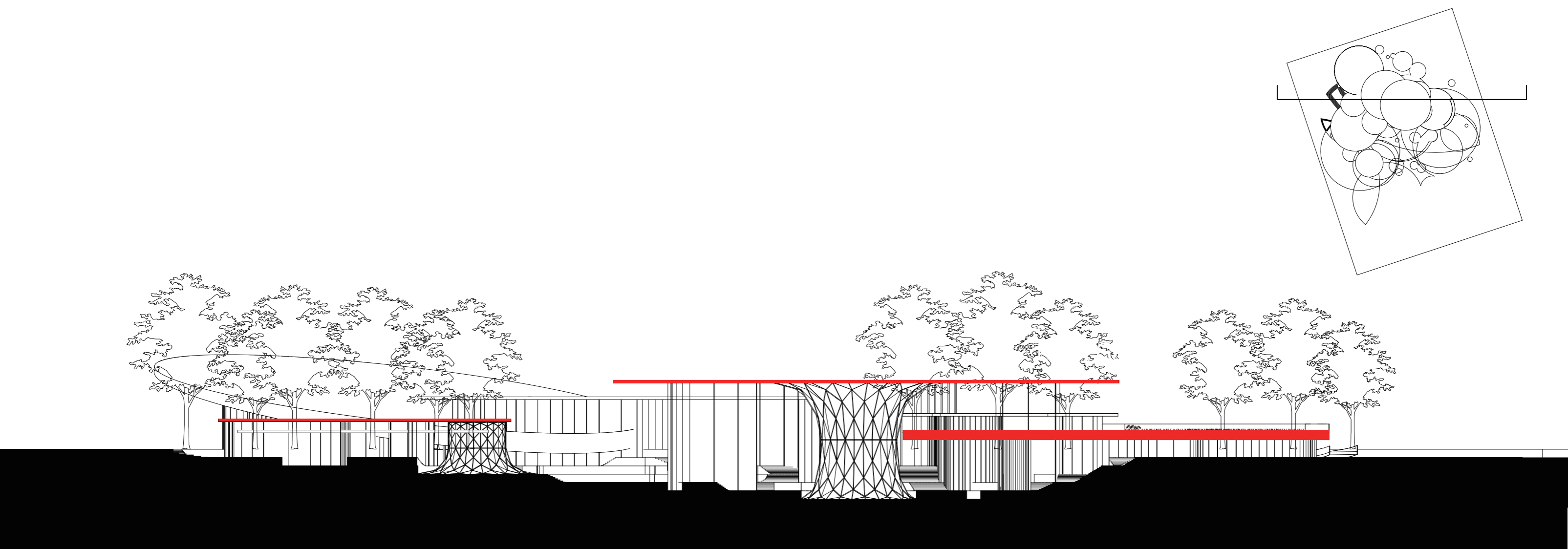
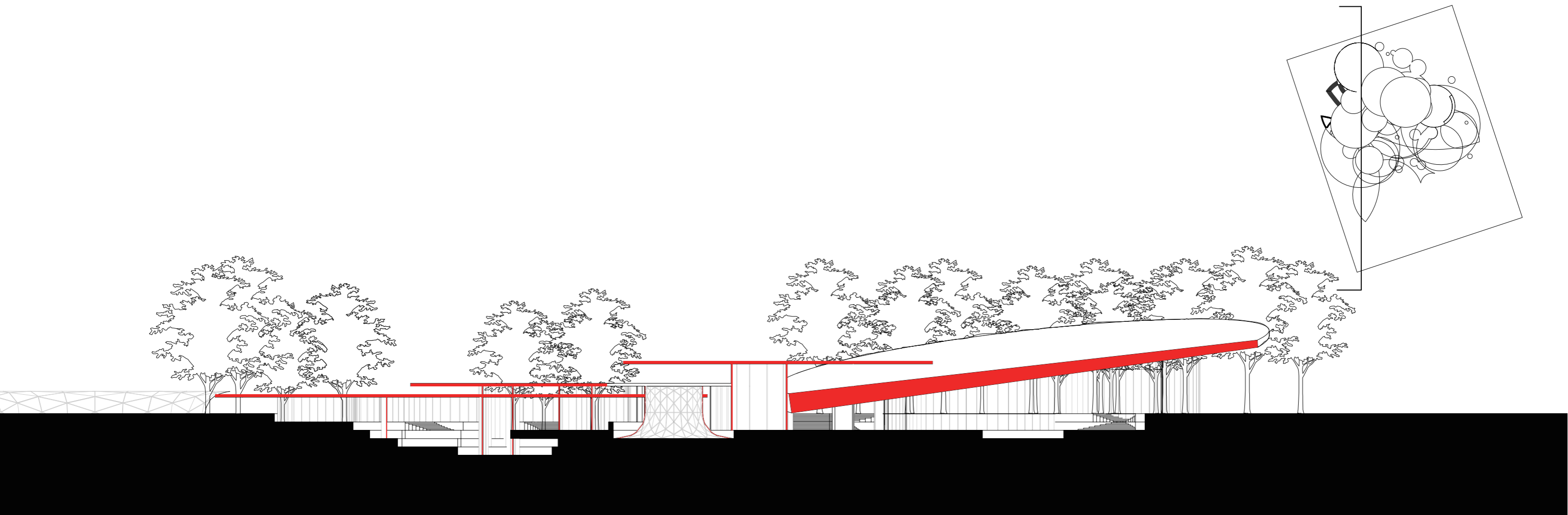

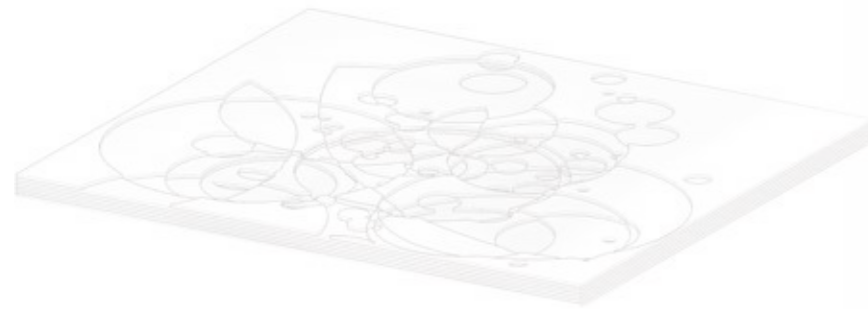
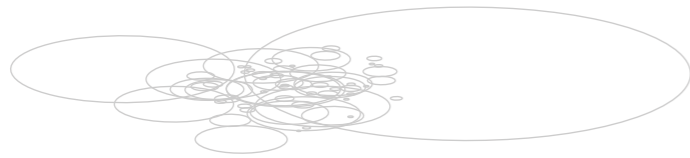

slab

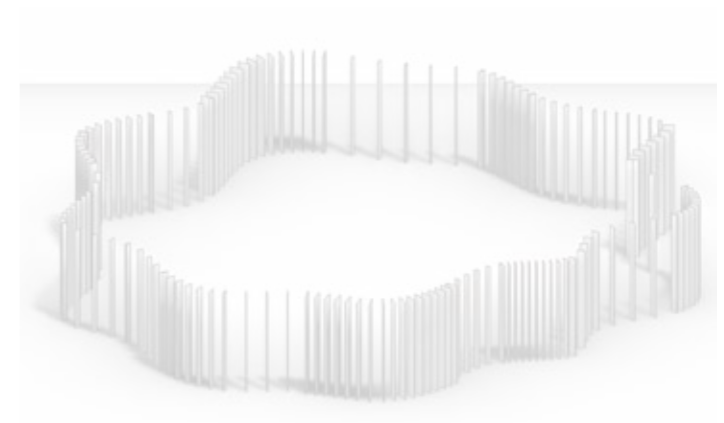
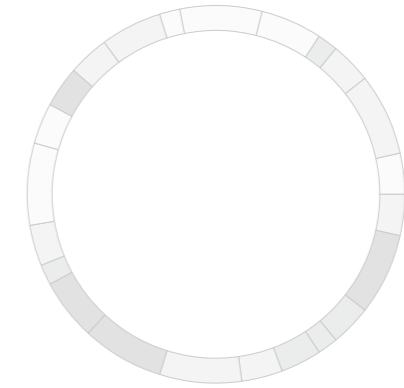
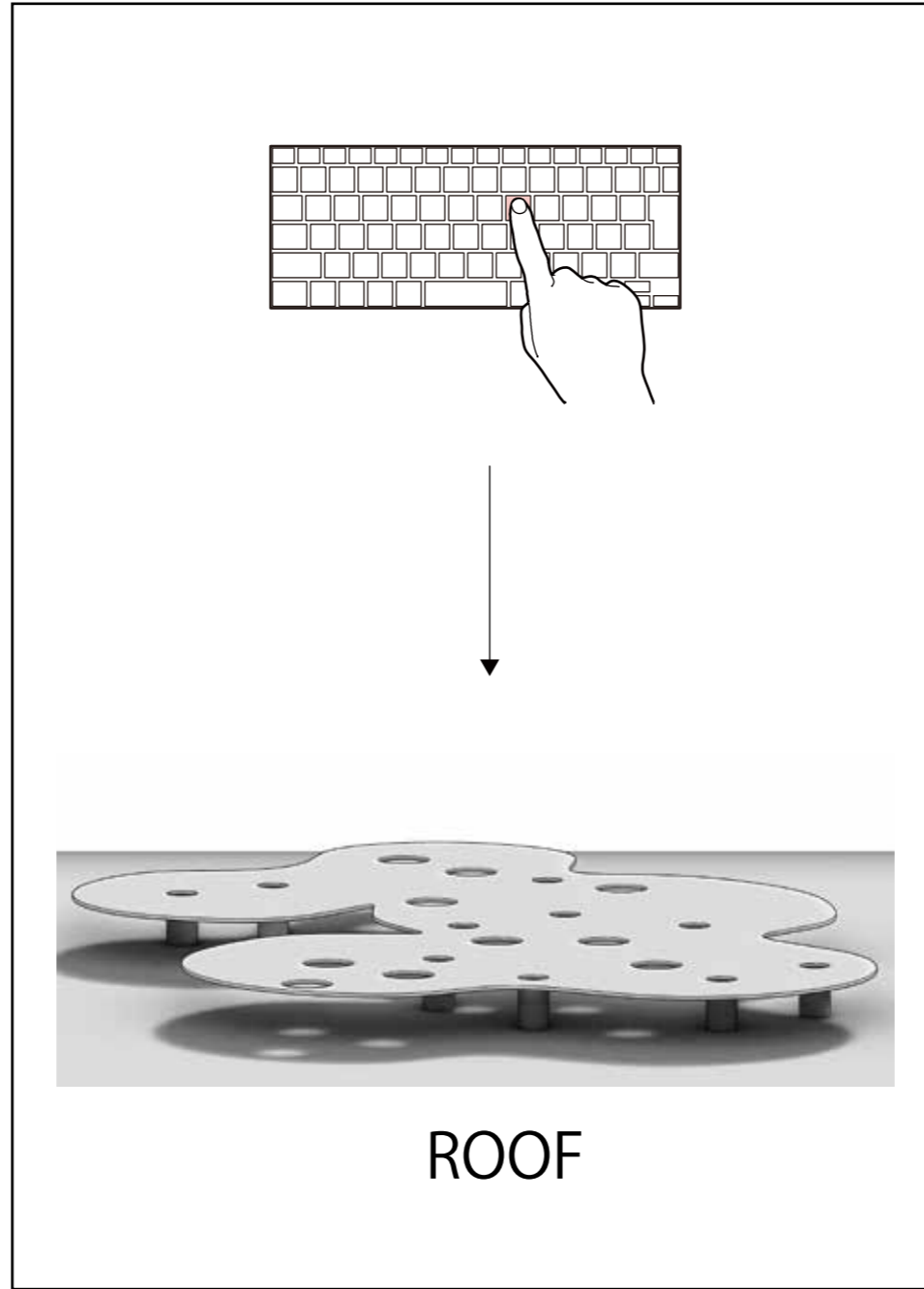

column

# Protocol - HIRAGANA

## Protocol Step

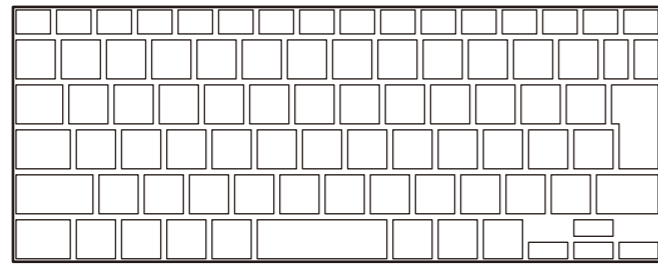

1. Record my keyboard push

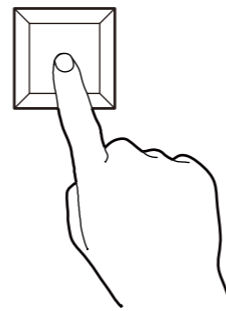

2. Count how many button I pushed

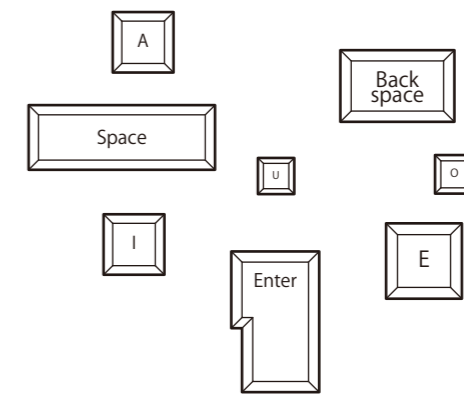

3. Analysis



# Protocol - HIRAGANA

Key logger

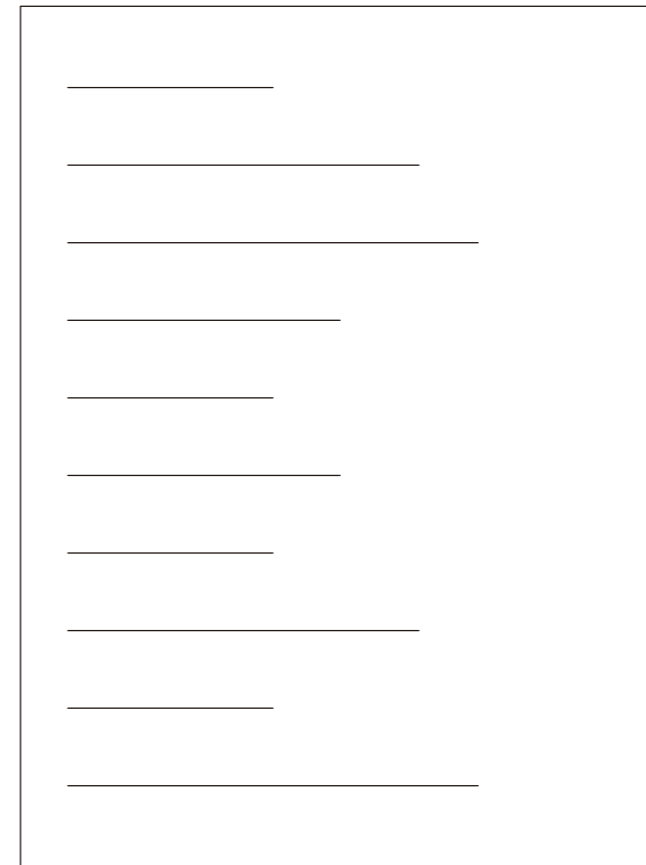
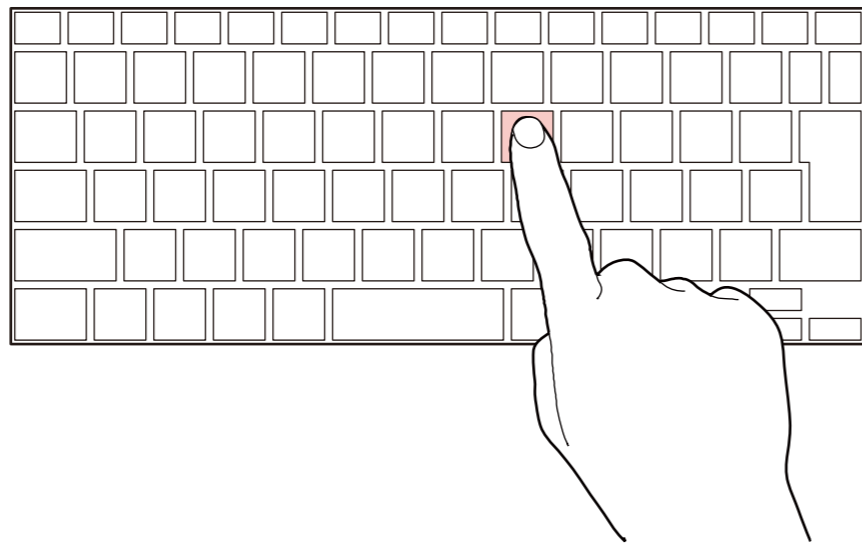

key logger generates .txt file

Protocol - HIRAGANA

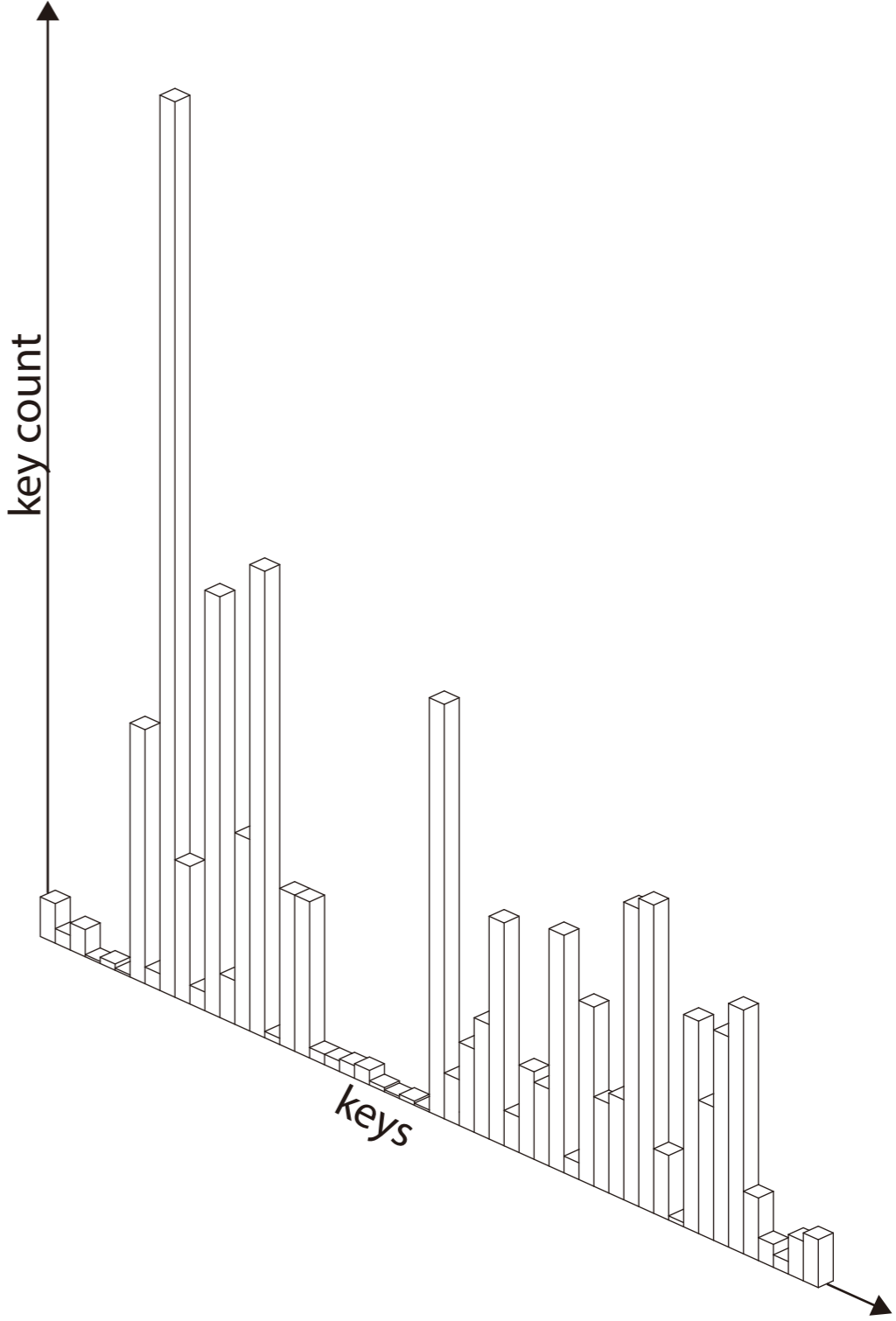
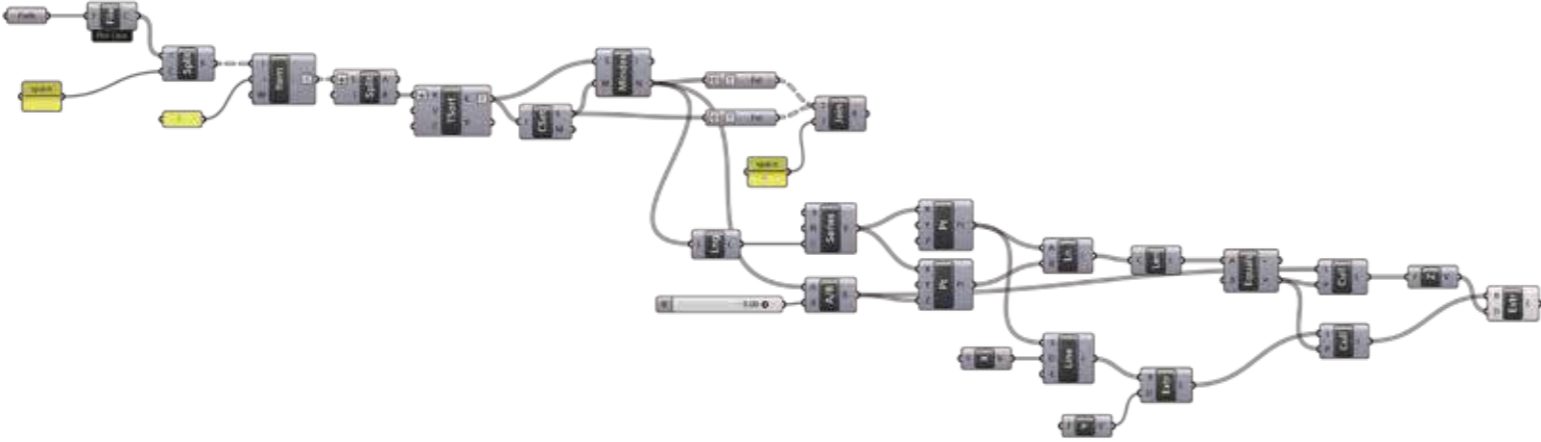

# Protocol - HIRAGANA

## Analysis

Top10 pushed alphabet

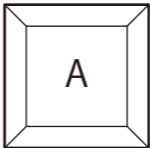
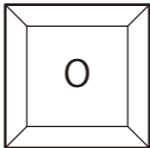
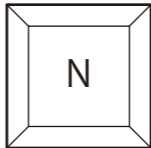
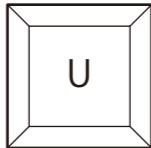
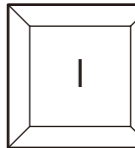
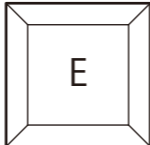
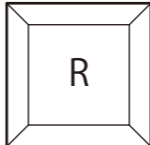
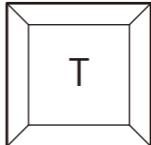
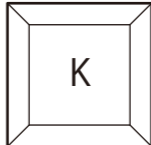
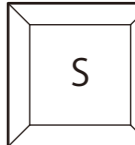
1. 
2. 
3. 
4. 
5. 
6. 
7. 
8. 
9. 
10. 

Top3 pushed other key

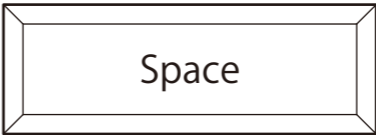
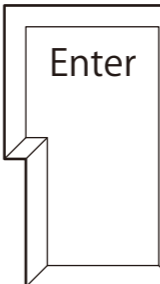
1. 
2. 
3. 

# Protocol - HIRAGANA

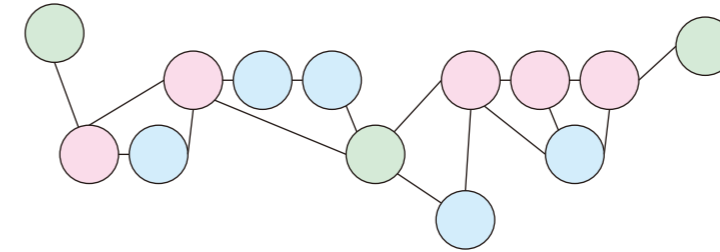
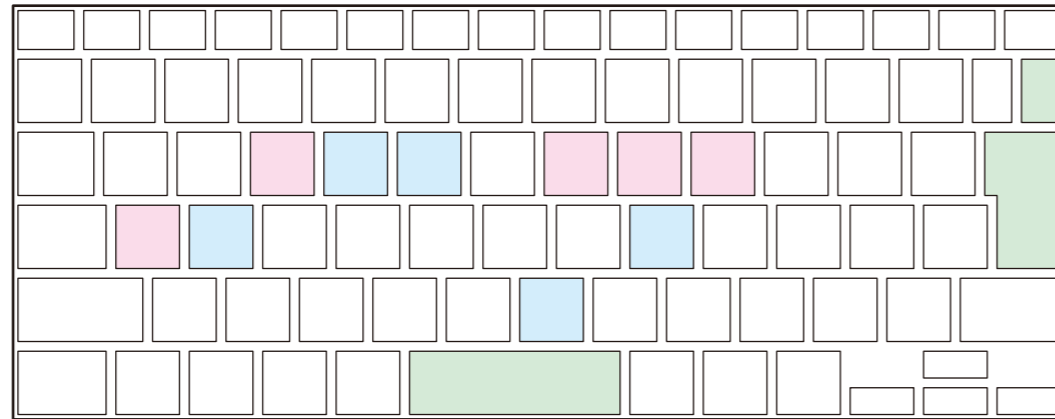

■ vowel  
(a,e,i,o,u)

core space → open space,coworking area.....  
(public)

■ consonant  
(s,t,r,n.....)

branch space → lecture room,meeting room.....  
(private) It is connected from vowel or other key.

■ other key  
(enter,space.....)

flexible space → entrance,exit....  
It can appear everywhere in plan  
because "enter" "space" can exist everywhere in sentence.

■ zoning

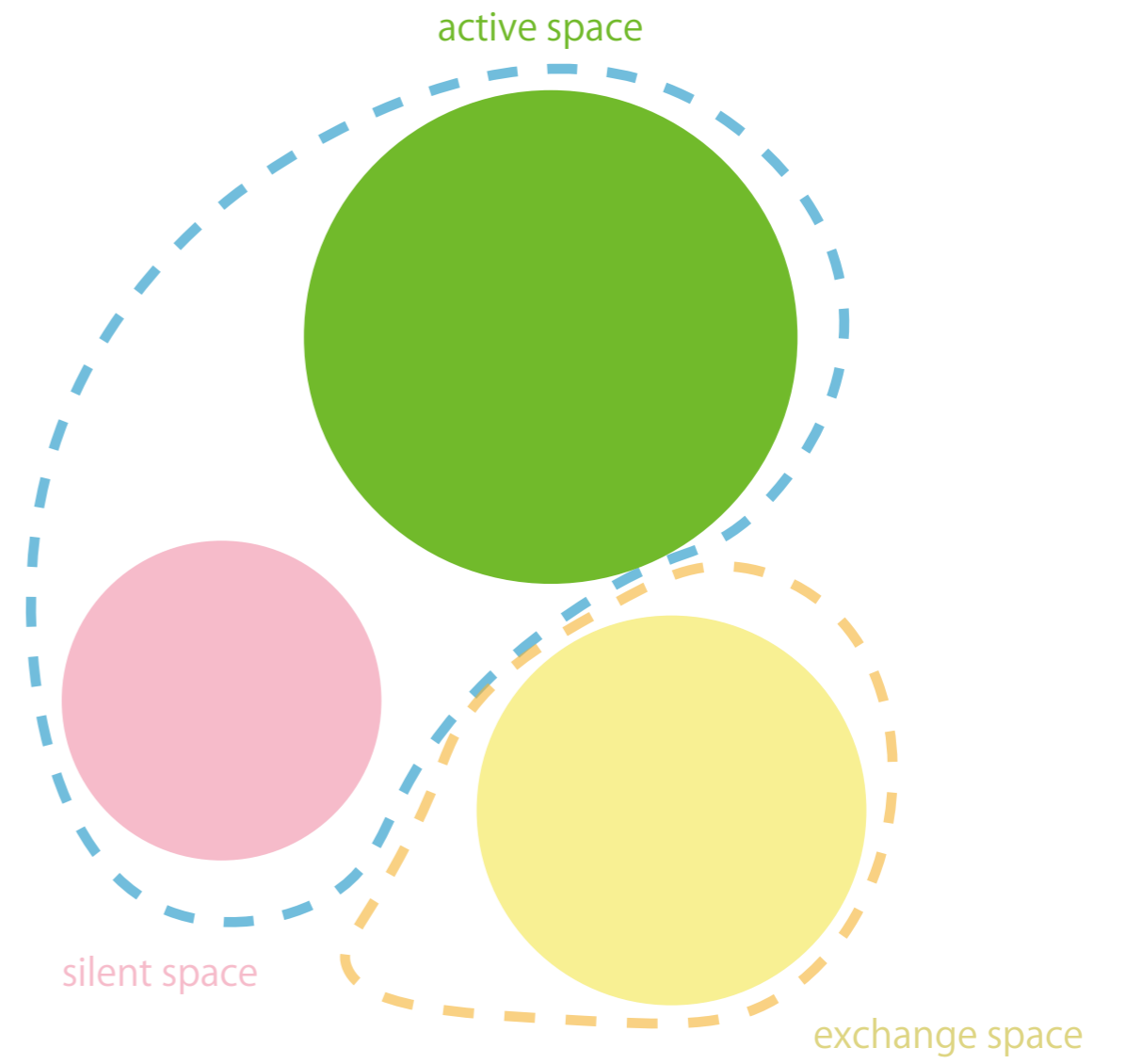
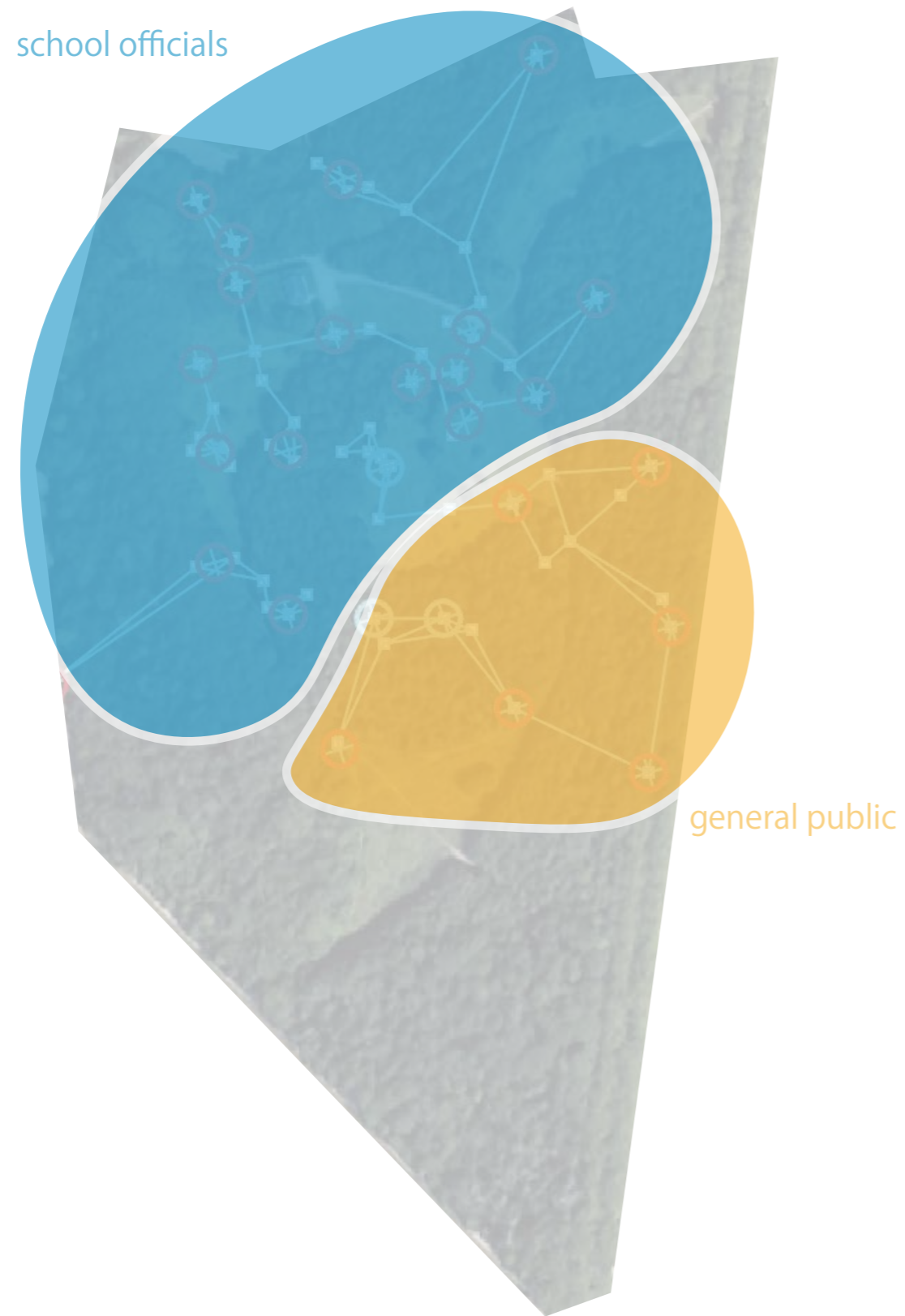

# ■ Constitution

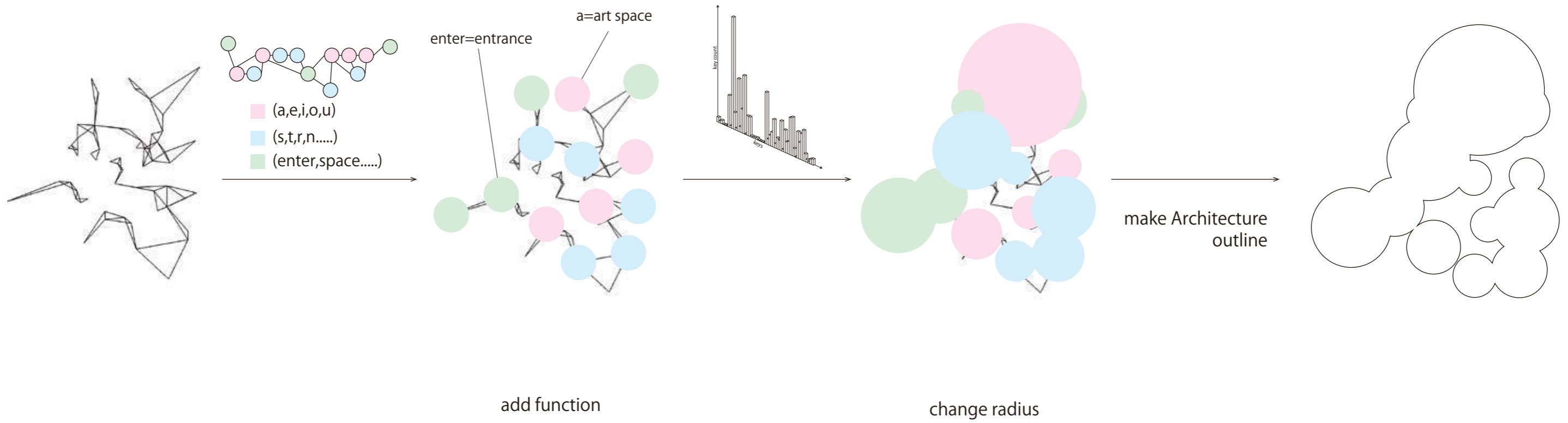

■ zoning

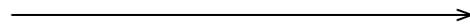
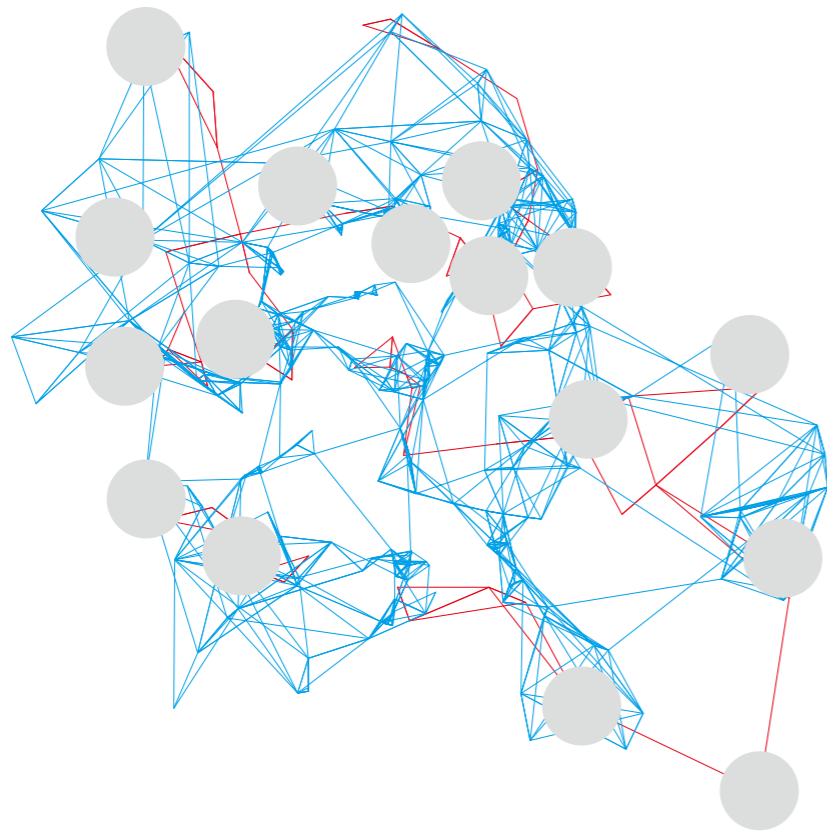

add function

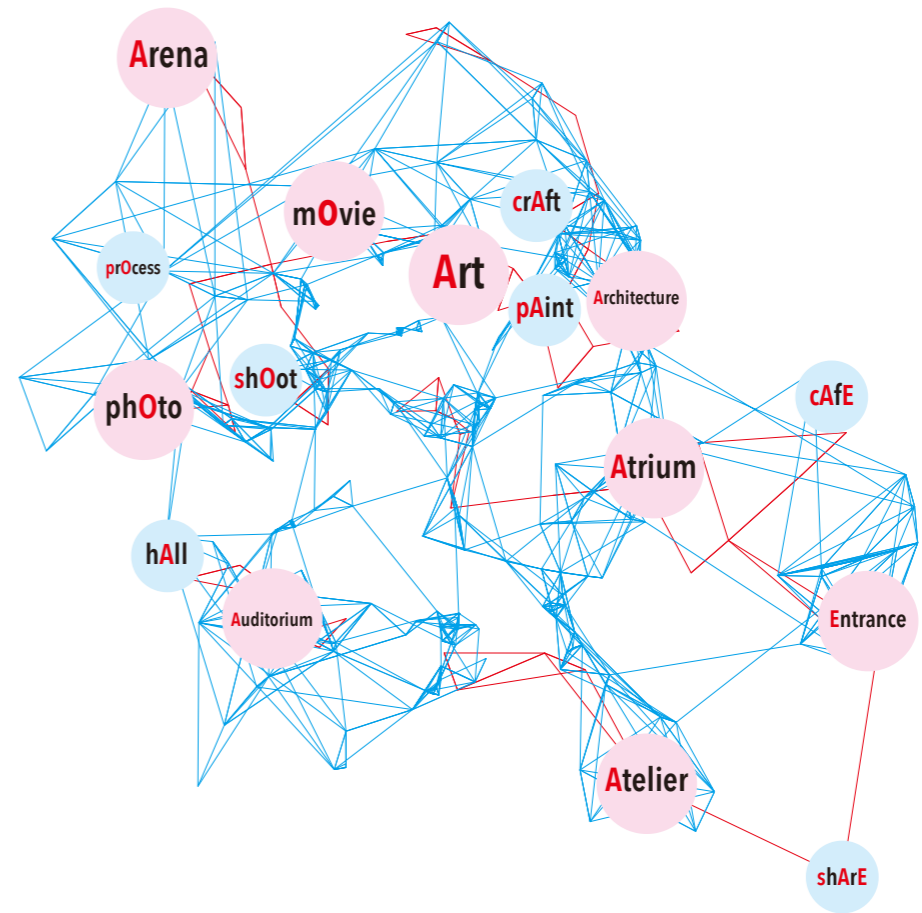

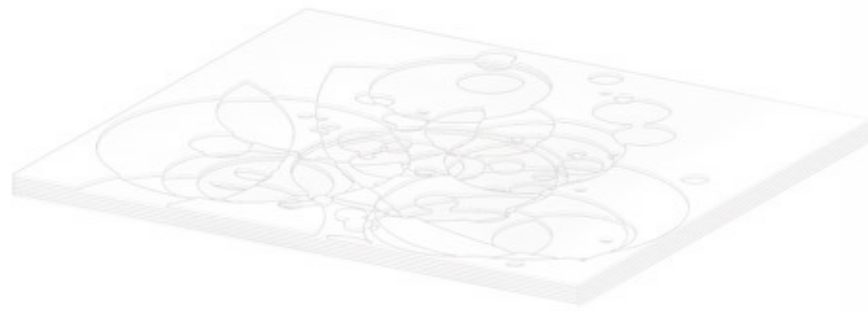
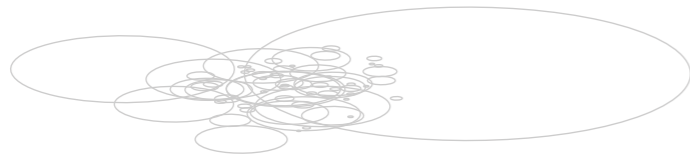

slab

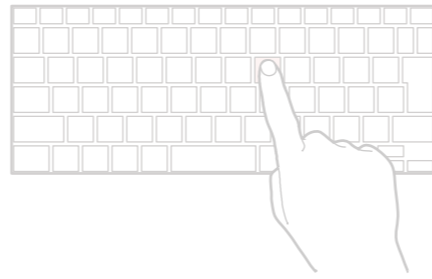

roof

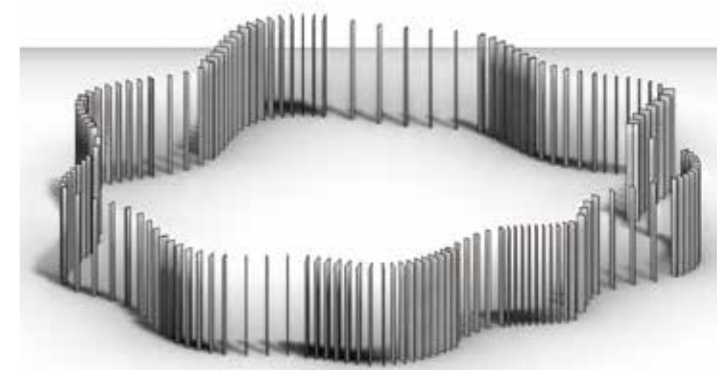
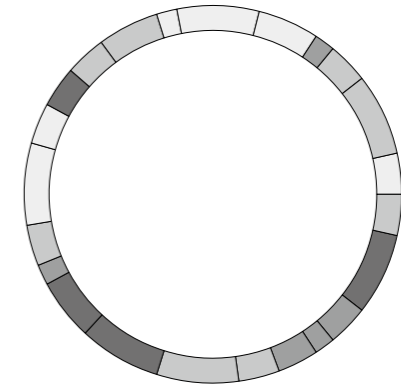

COLUMN



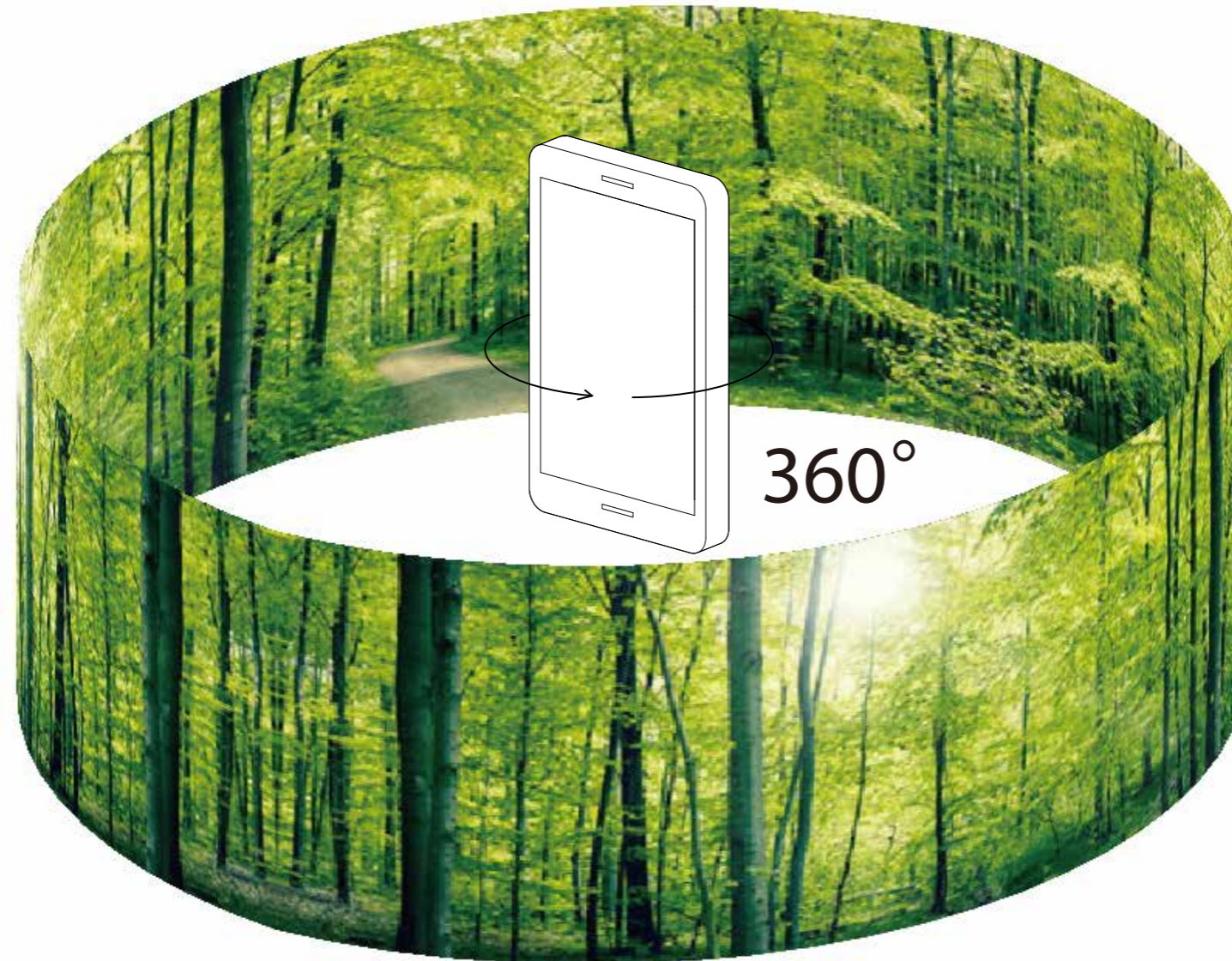

Panoramic photo

■ Site Information



Divide picture in to 25 pieces



Extract color average



■ Columns arrangement

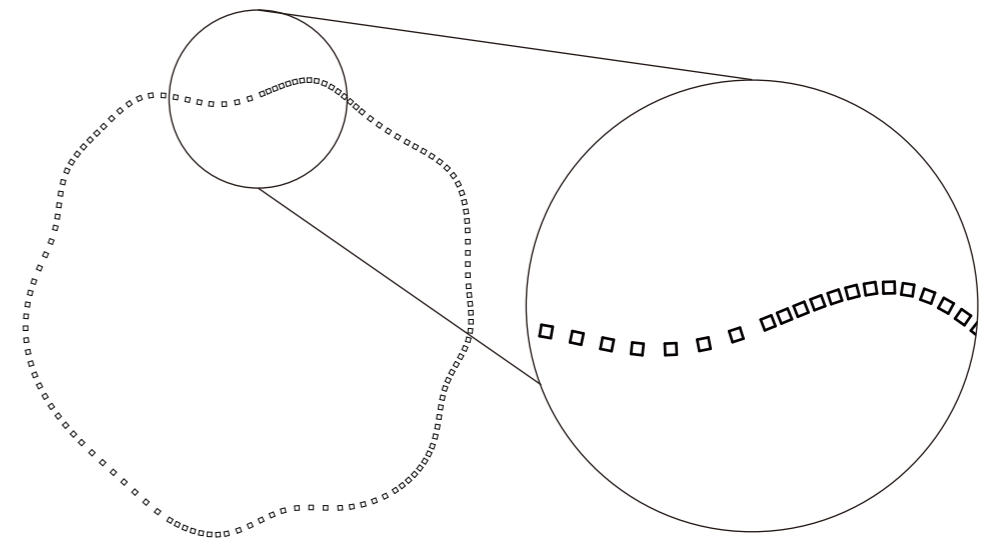
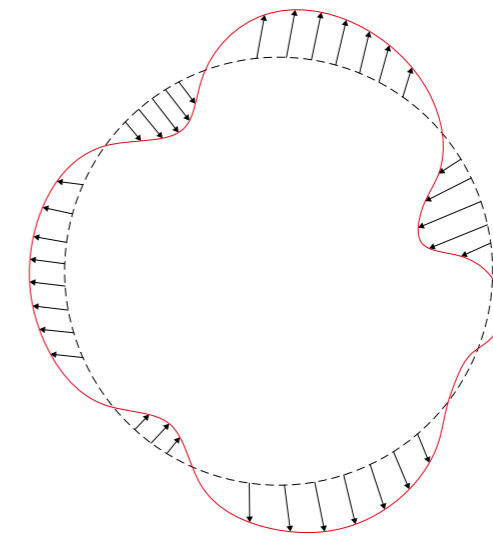

■ Size of columns

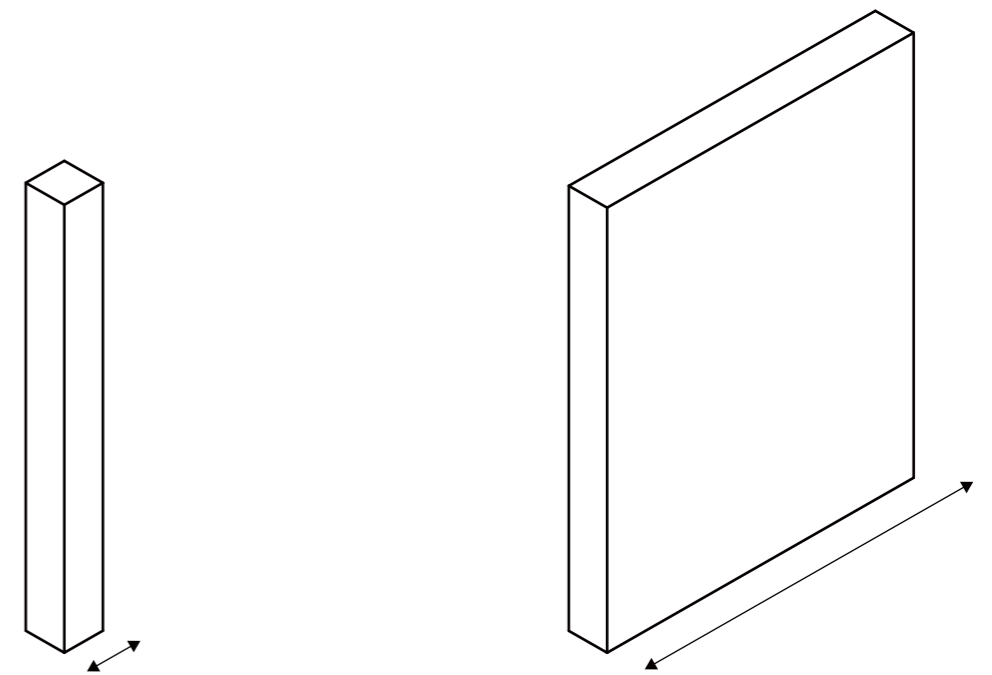
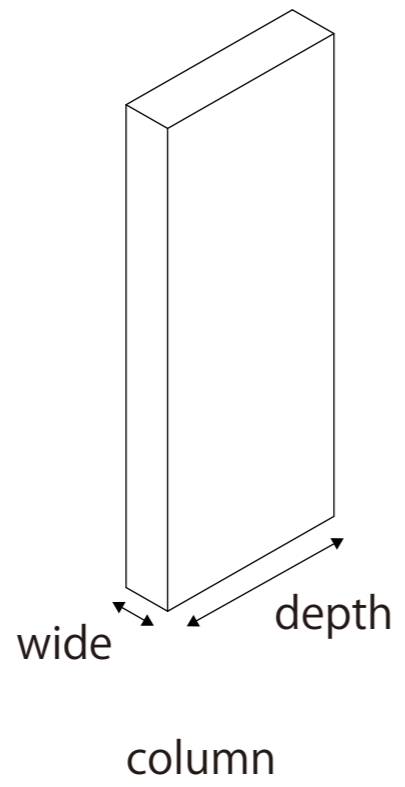
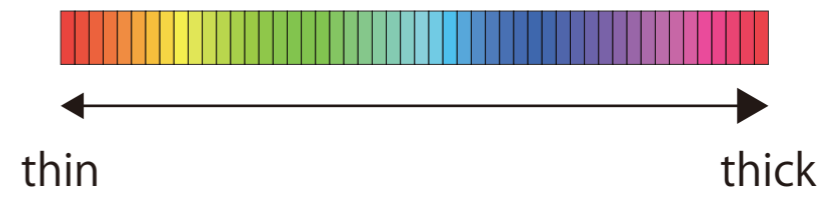
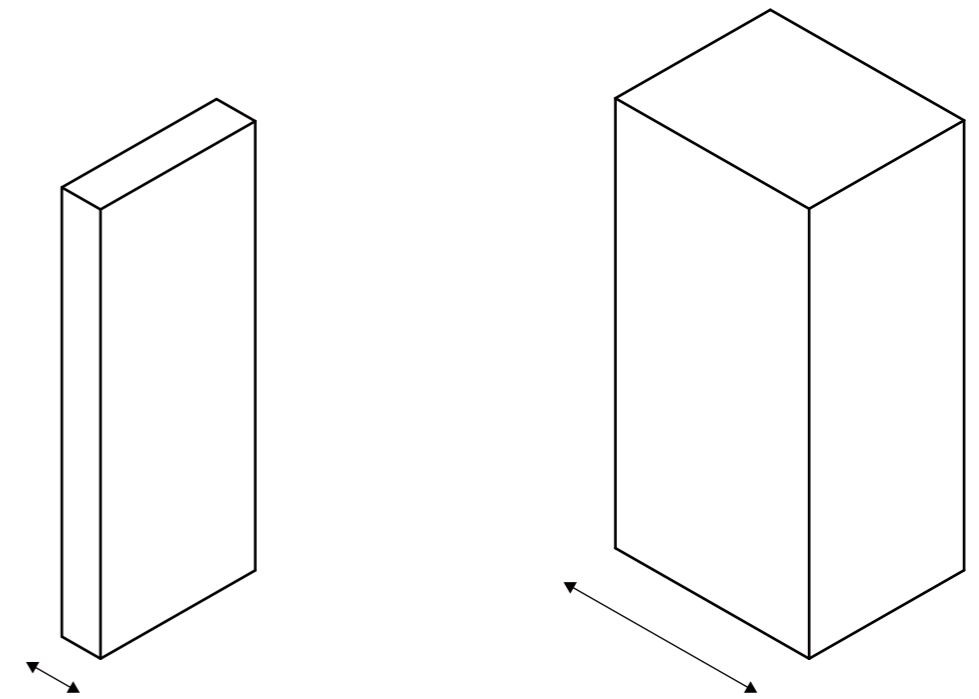







no connection  
between  
Roof and Slub

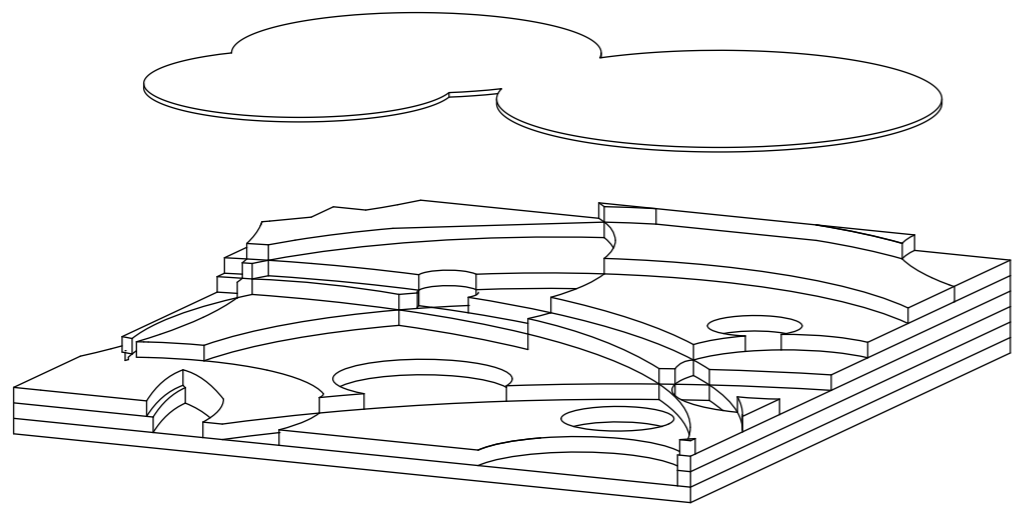

make cylinder  
to connect

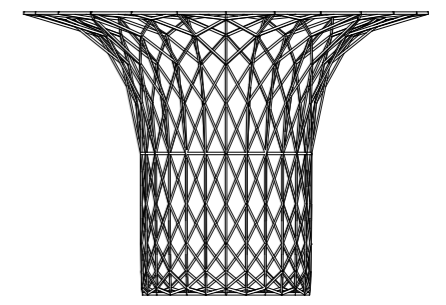
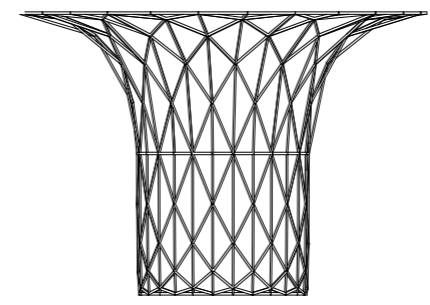
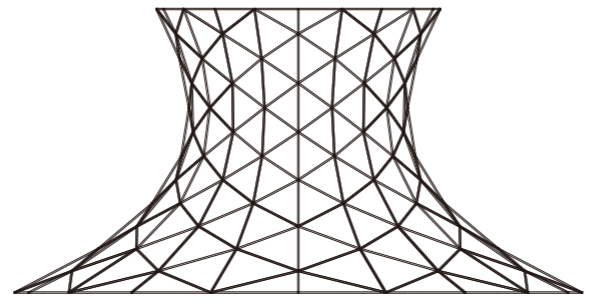
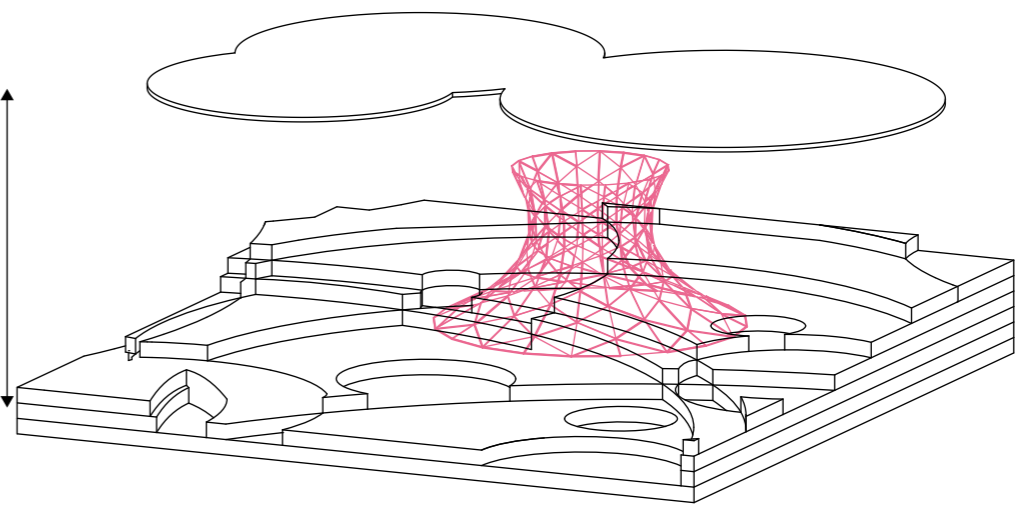

cylinder shape made from  
1. space function  
2. to make interior or exterior

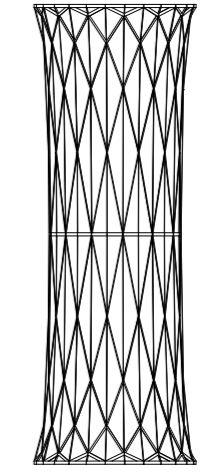
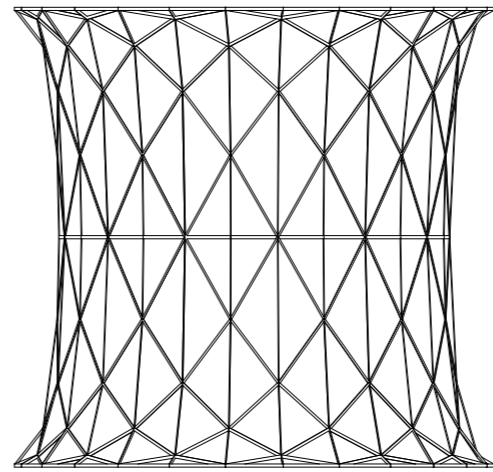
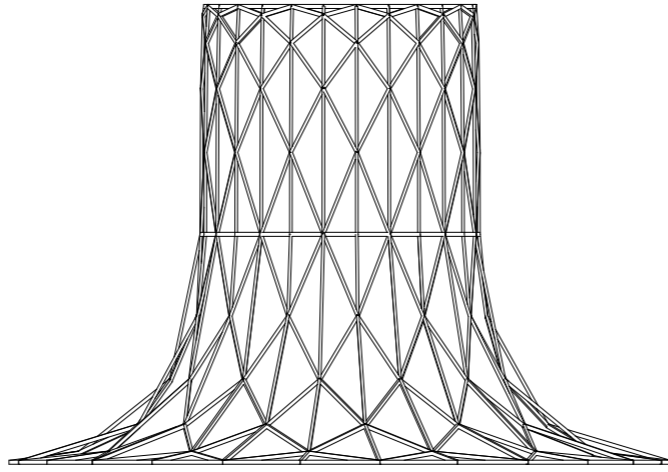

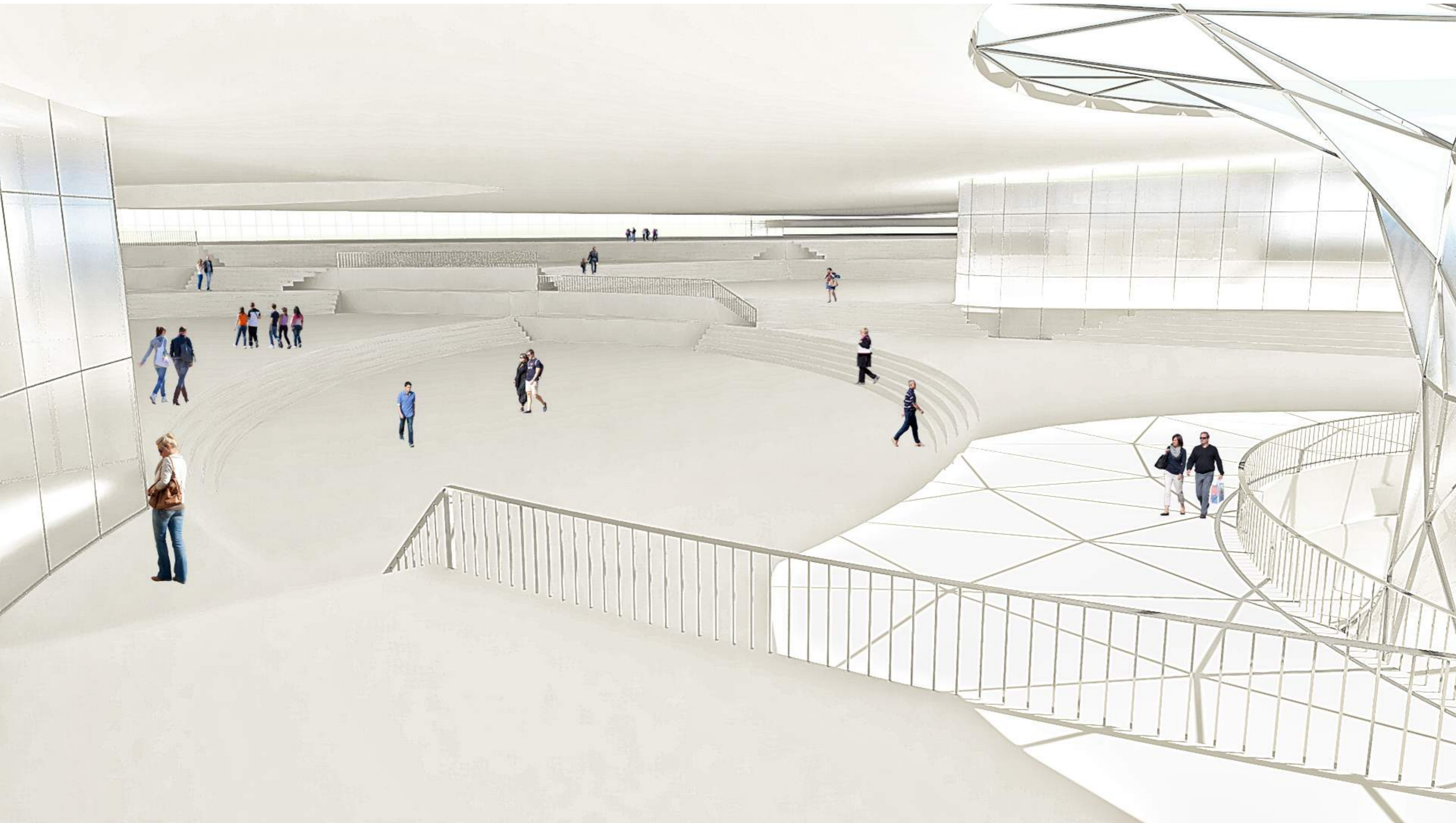



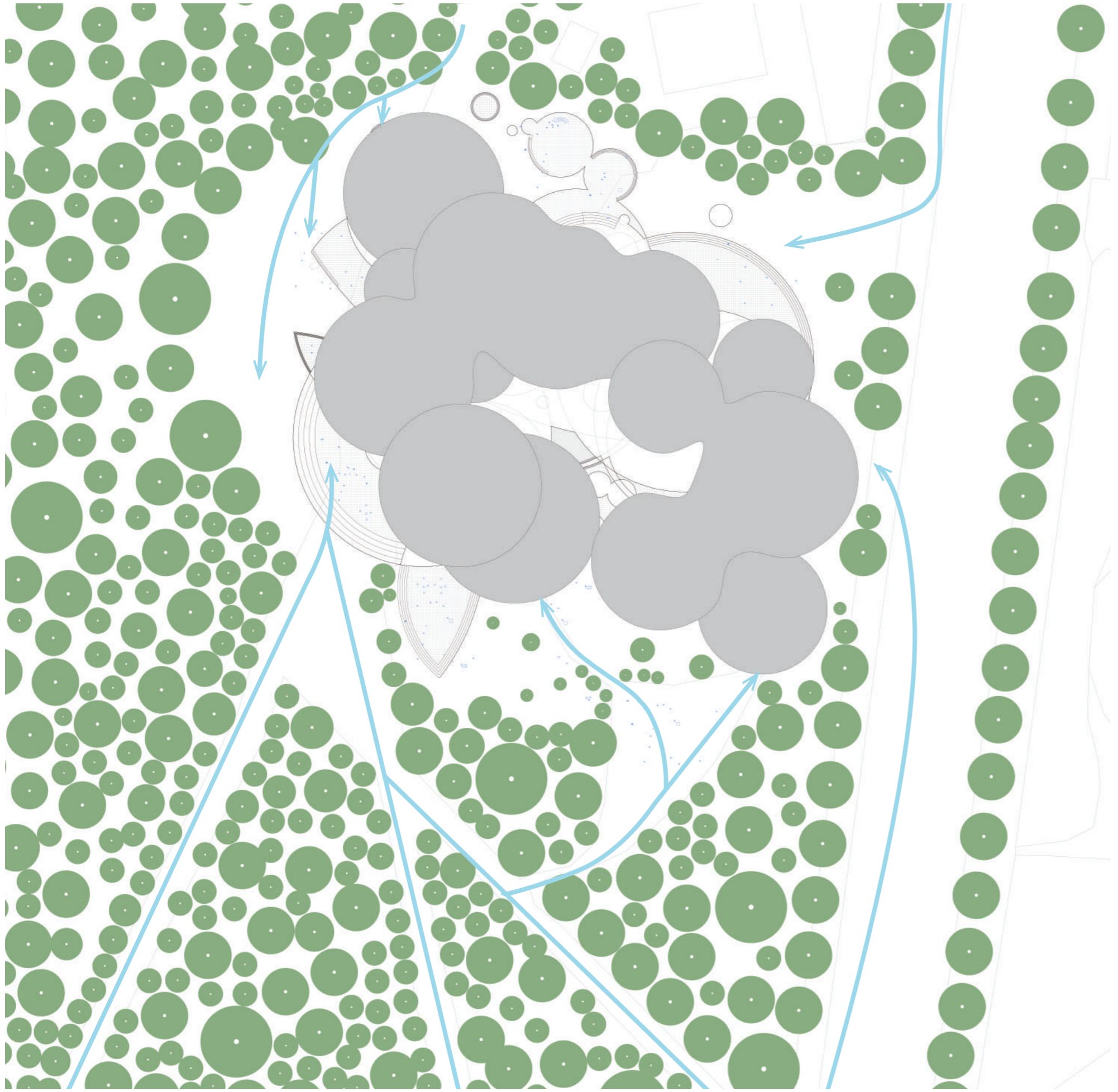



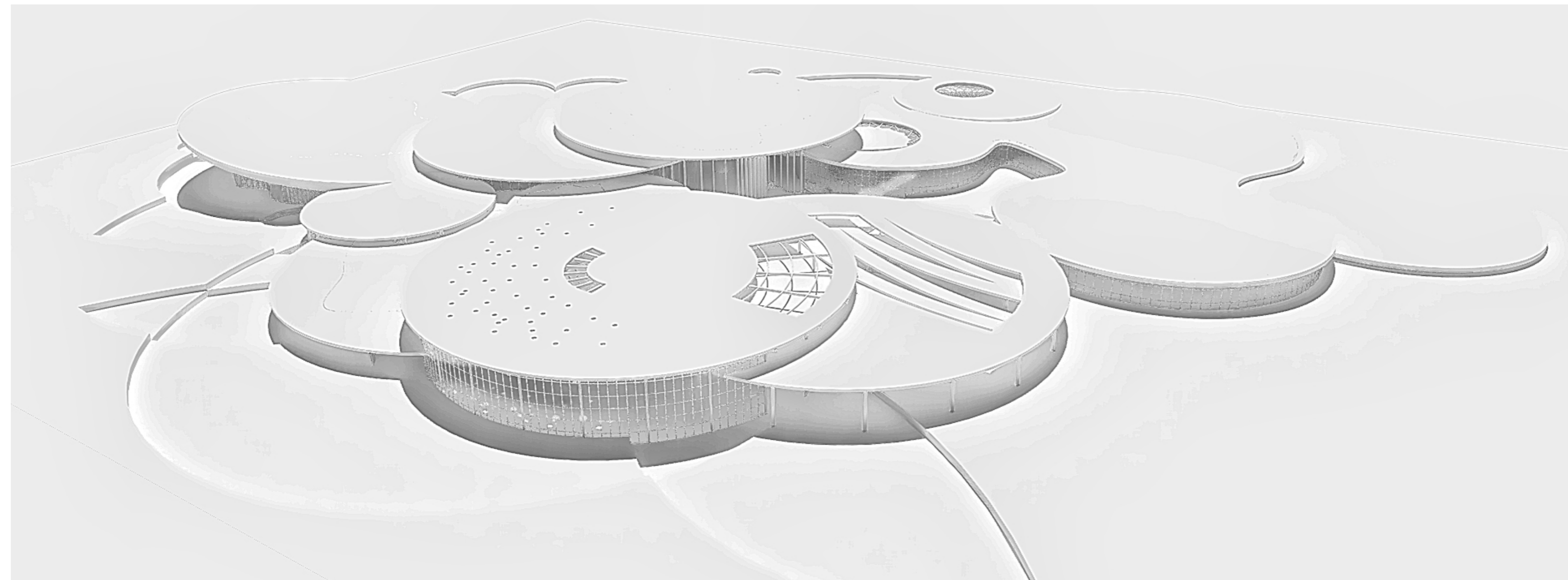

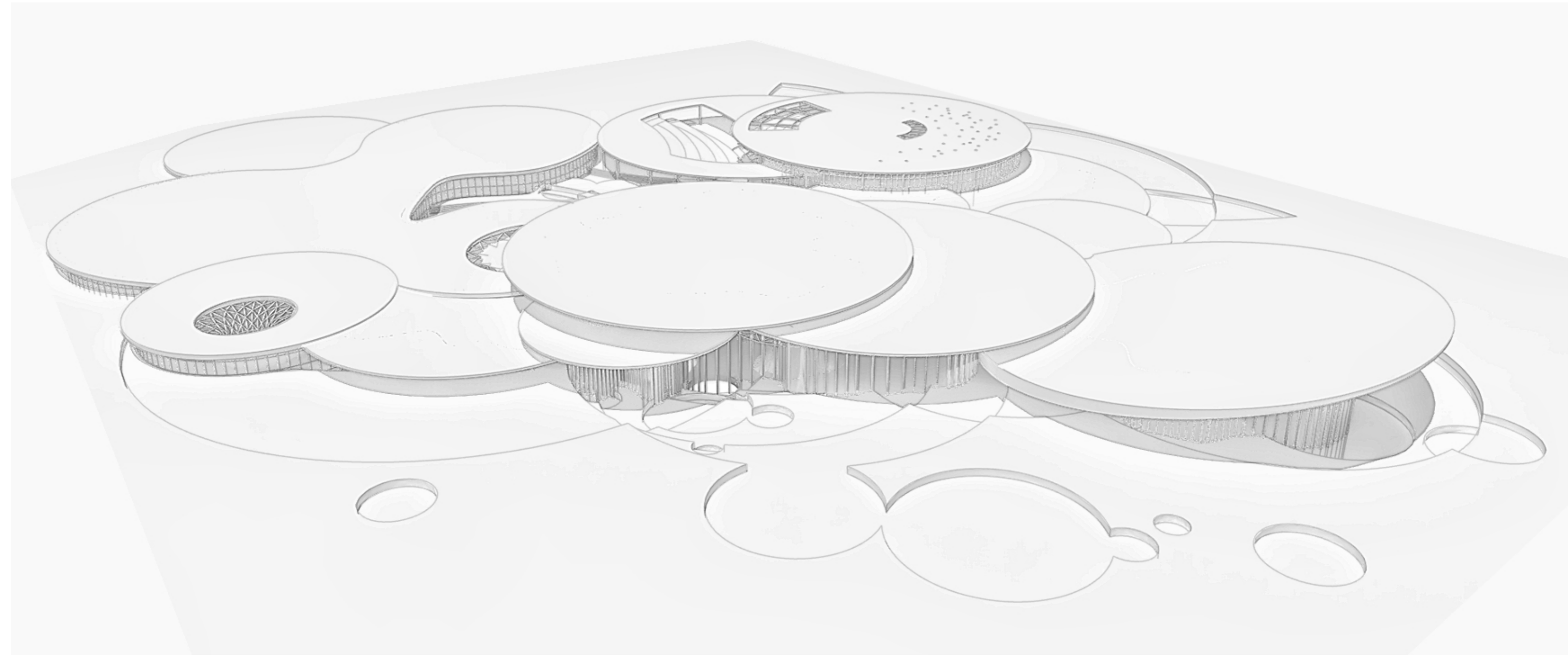

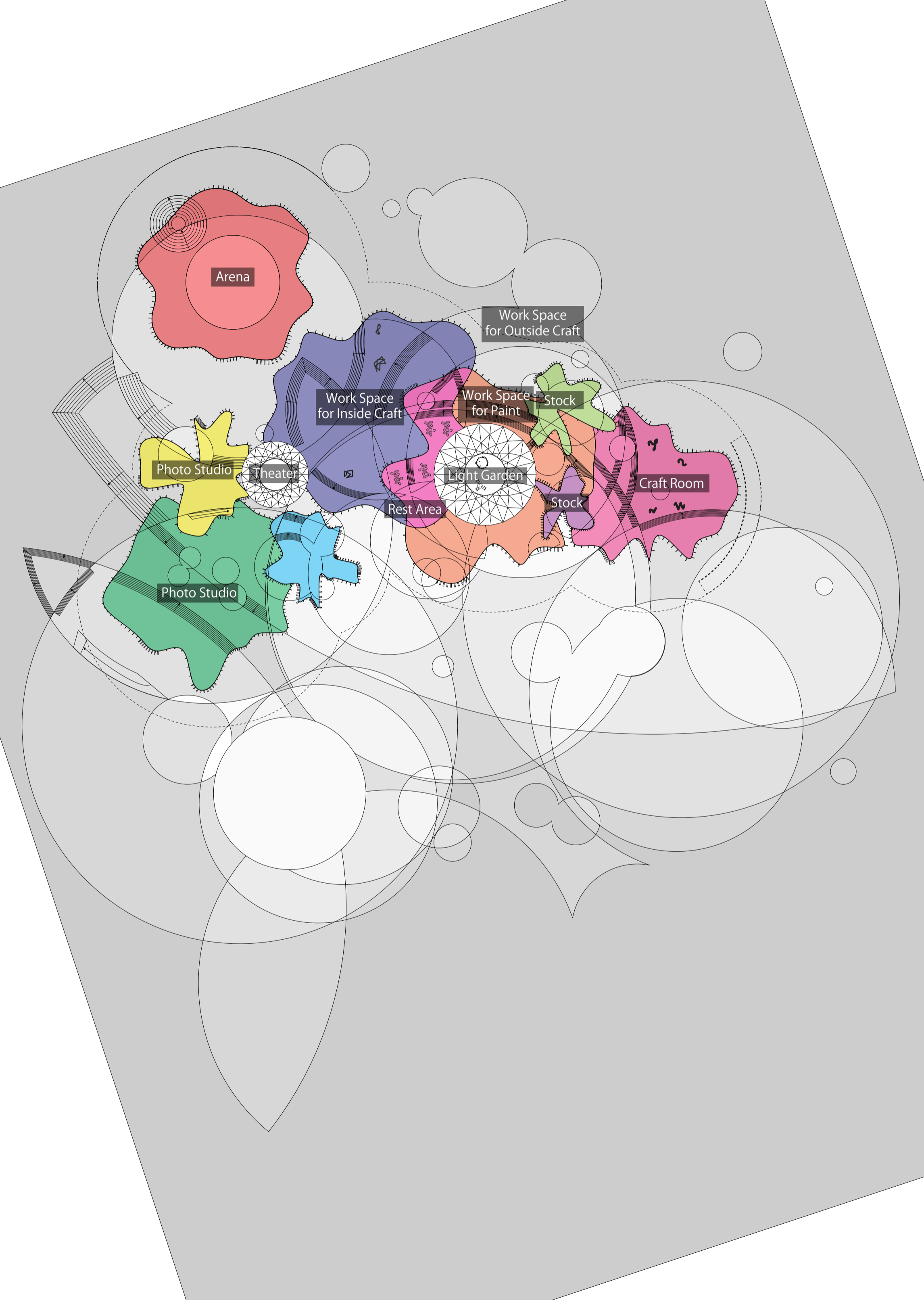

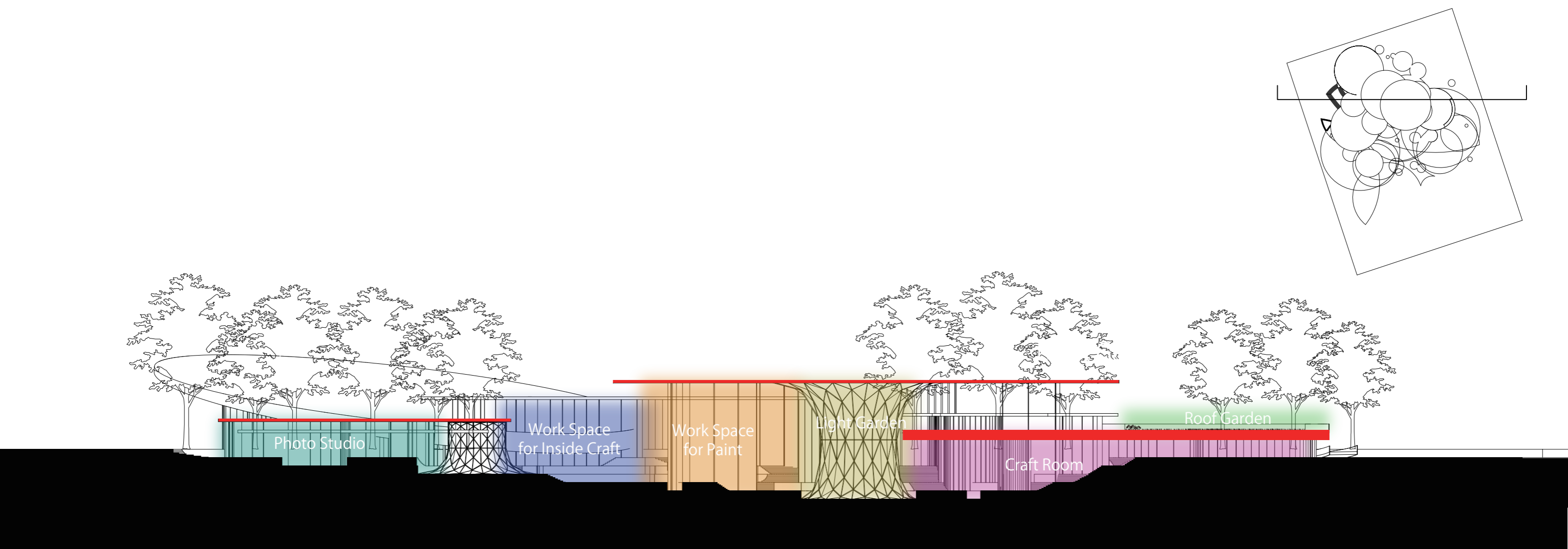
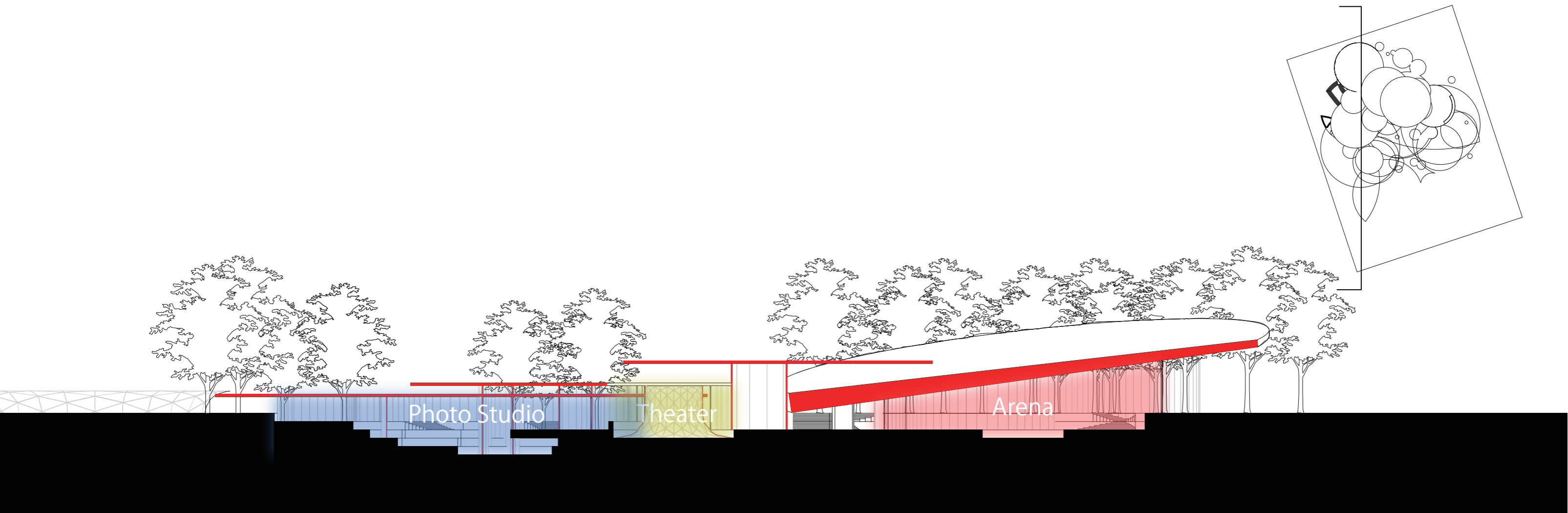



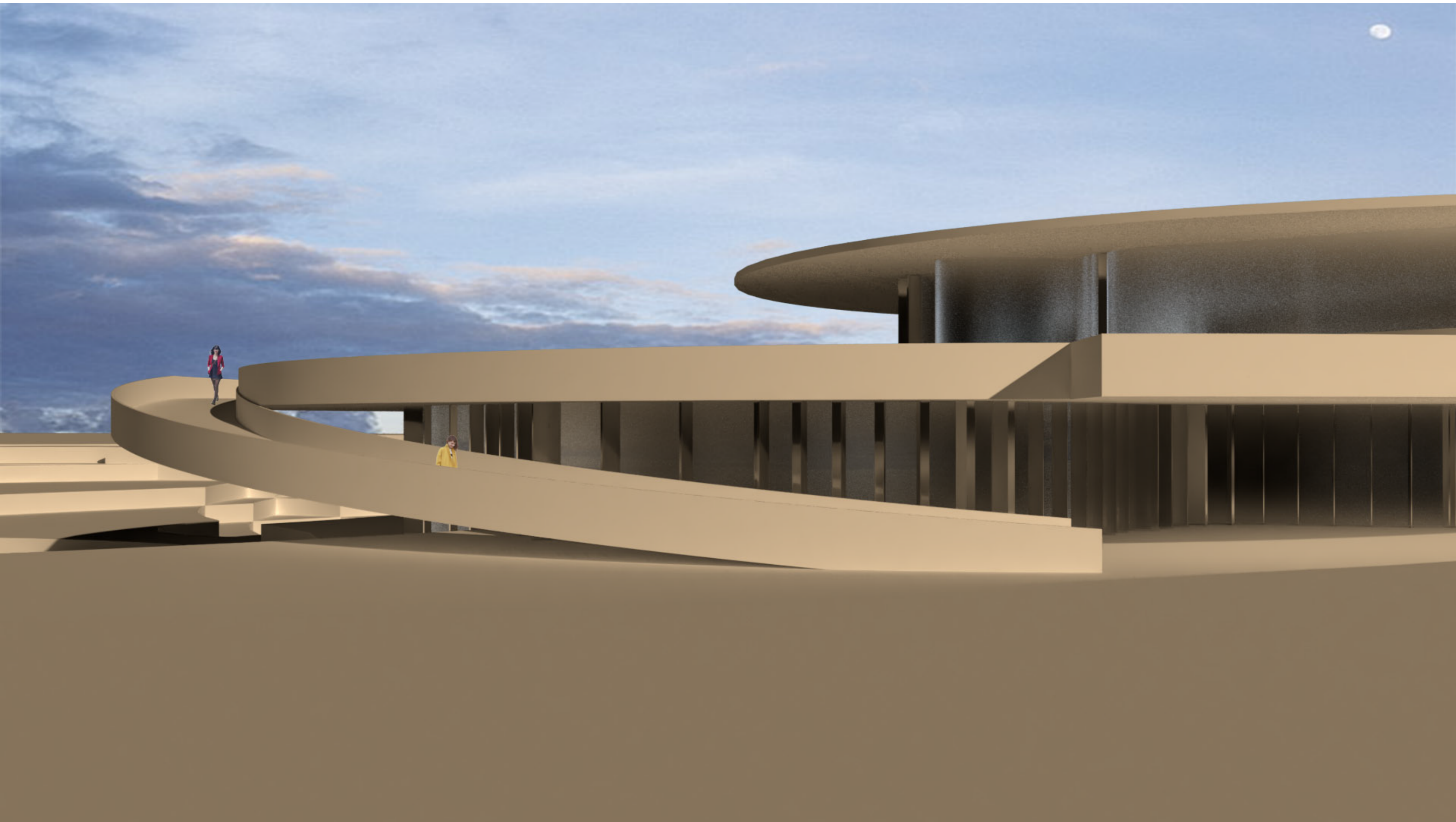

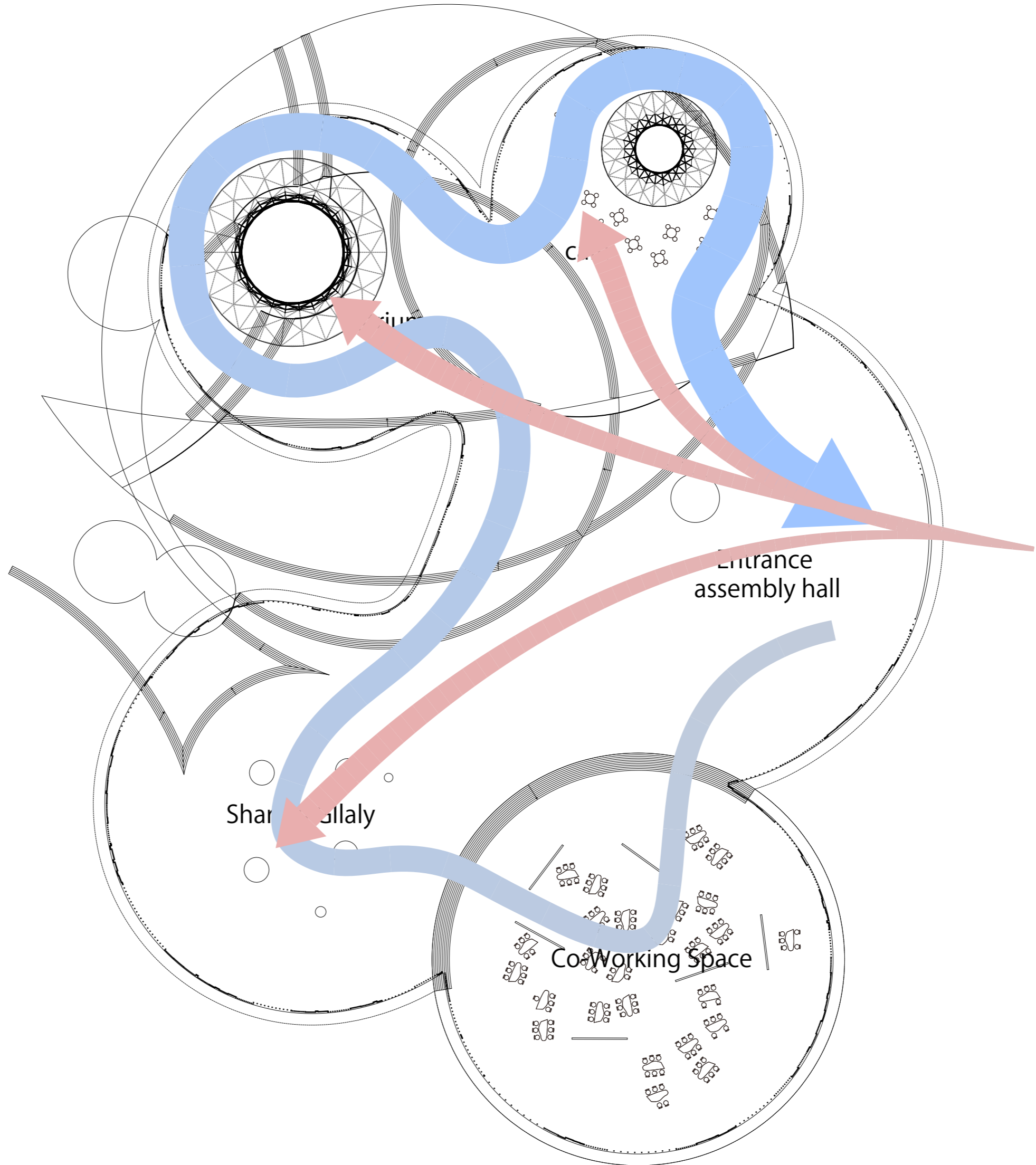

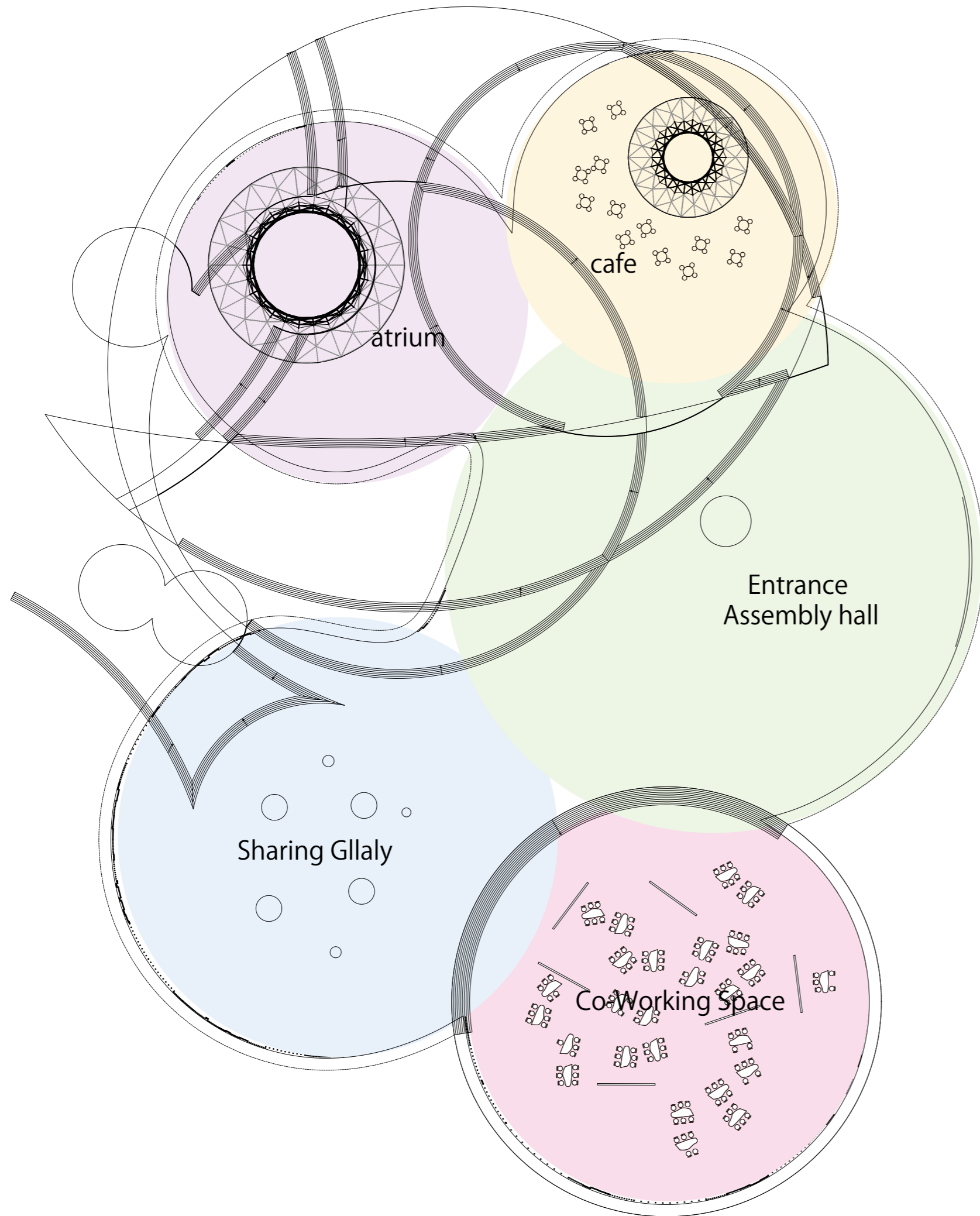

- Entrance, Assembly hall  
 Booking Co-Working space, Gallery etc...
  
- Atrium  
 People can gather in this space while break time
  
- Co-Working Space  
 Student and Citizen can use this area freely for studying ,working etc...
  
- Cafe
  
- Sharing Gallery  
 People can do exhibition for their own art.



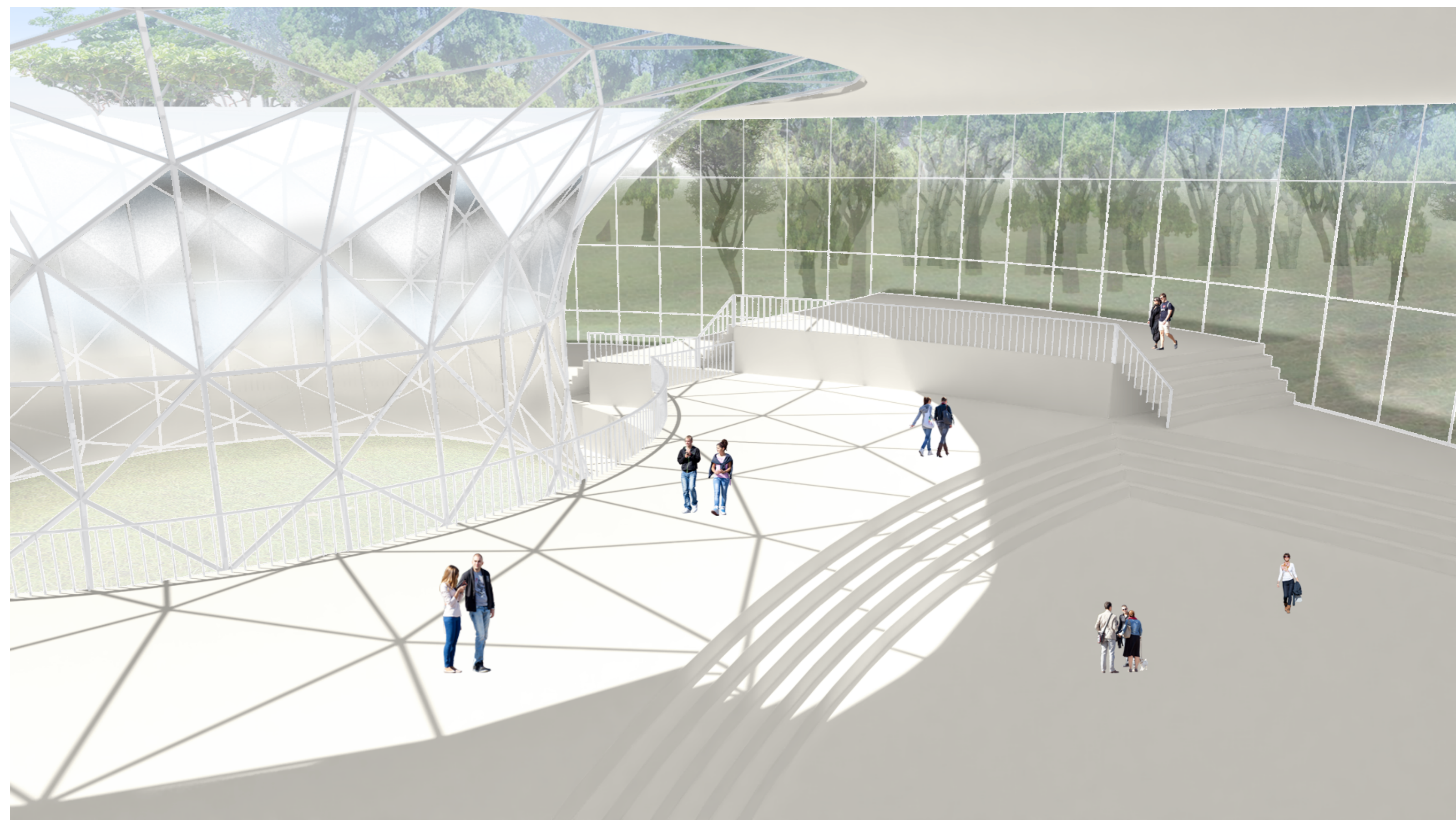



beam



void

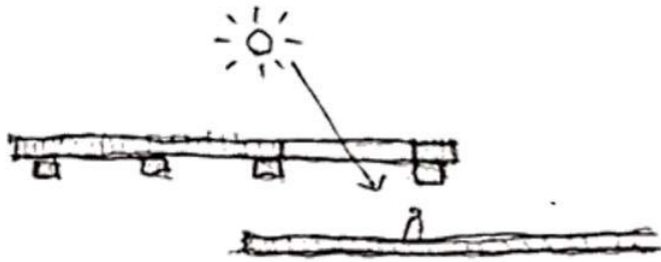

silent space

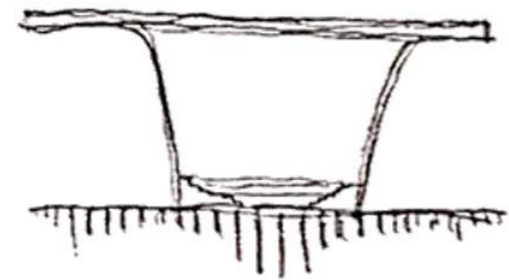

void

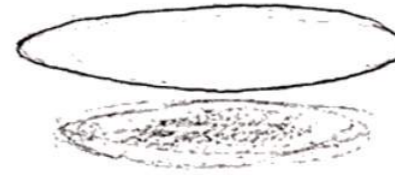

slope



come into

